

Dear Customer,

Thank you for purchasing the JVC VHS video cassette recorder. Before use, please read the safety information and precautions contained on this page to ensure safe use of your new VCR.

CAUTIONS

WARNING: DANGEROUS VOLTAGE INSIDE
WARNING: TO PREVENT FIRE OR SHOCK HAZARD, DO NOT EXPOSE THIS UNIT TO RAIN OR MOISTURE.

The POWER I/O button does not completely shut off mains power from the unit, but switches operating current on and off. " I " shows electrical power standby and " O " shows ON.

This unit is produced to comply with Standard IEC Publ. 65.

POWER SYSTEM:

This set operates on voltage of AC 110 – 220V~, 50/60 Hz with automatic switching.

The rating plate and safety caution are on the rear of the unit.

IMPORTANT:

It may be unlawful to record or play back copyrighted material without the consent of the copyright owner.

CAUTION

- When you are not using the VCR for a long period of time, it is recommended that you disconnect the power cord from the AC outlet.
- Dangerous voltage inside. Refer internal servicing to qualified service personnel. To prevent electric shock or fire hazard, remove the power cord from the AC outlet prior to connecting or disconnecting any signal lead or aerial.
- Changes or modifications not approved by JVC could void user's authority to operate the equipment.

Warning on lithium battery

The battery used in this device may present a fire or chemical burn hazard if mistreated. Do not recharge, disassemble, heat above 100°C or incinerate. Replace battery with Panasonic (Matsushita Electric), Sanyo, Sony or Maxell CR2025; use of another battery may present a risk of fire or explosion.

- Dispose of used battery promptly.
- Keep away from children.
- Do not disassemble and do not dispose of in fire.

HOW TO USE THIS INSTRUCTION MANUAL

- All major sections and subsections are listed in the Table Of Contents on page 3. Use this when searching for information on a specific procedure or feature.
- The Index on pages 34 – 36 lists frequently-used terms, and the number of the first page on which they are used or explained in the manual. This section also illustrates the controls and connections on the front and rear panel, the front display panel and the remote control.
- The  mark signals a reference to another page for instructions or related information.
- Operation buttons necessary for the various procedures are clearly indicated through the use of illustrations at the beginning of each major section.

BEFORE YOU INSTALL YOUR NEW VCR . . .

. . . please read thoroughly the cautions on this page.

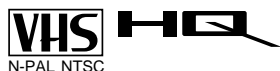

- Cassettes marked "VHS" (or "S-VHS") can be used with this video cassette recorder. However, only "VHS" recordings can be played back in this model.
- HQ VHS is compatible with existing VHS equipment.

I **NSTALLING YOUR NEW VCR** **4**

Basic Connections 4

I **NITIAL SETTINGS** **6**

Plug & Play 6

Language 8

Clock 9

Summer Time (Daylight saving time) 11

Tuner 12

Set Receivable Channels 12

Add Or Delete A Channel 13

S **IMPLE PLAYBACK AND RECORDING** **14**

Simple Playback 14

Simple Recording 15

P **LAYBACK AND RECORDING FEATURES** **16**

Playback Features 16

Still Picture/Frame-By-Frame Playback 16

Slow Motion/Reverse Slow Motion 16

Variable-Speed Search/Reverse Motion Playback 16

High-Speed Search 17

Index Search 17

Manual Tracking 17

Repeat Playback 18

Counter Reset 18

Tape Position Indicator 18

Next-Function Memory 18

Superimpose 19

B.E.S.T. Picture System 20

Preparation 20

Playback 21

Recording 21

Video System 22

Recording Features 23

Record One Program While

Watching Another 23

Display Elapsed Recording Time 23

T **IMER RECORDING** **24**

Express Timer Programming 24

Check, Cancel And Revise Programs 26

Auto SP→LP Timer 27

Auto Timer 27

Instant Timer Recording (ITR) 28

E **DITING** **29**

Edit To Another VCR 29

Edit From A Camcorder Or Another VCR 30

Q **UESTIONS AND ANSWERS** **31**

PLAYBACK 31

RECORDING 31

TIMER RECORDING 31

T **ROUBLESHOOTING** **32**

POWER 32

TAPE TRANSPORT 32

PLAYBACK 32

RECORDING 32

TIMER RECORDING 33

OTHER PROBLEMS 33

I **NDIX** **34**

FRONT VIEW 34

REAR VIEW 35

FRONT DISPLAY PANEL 35

REMOTE CONTROL 36

S **PECIFICATIONS** **37**

Basic Connections

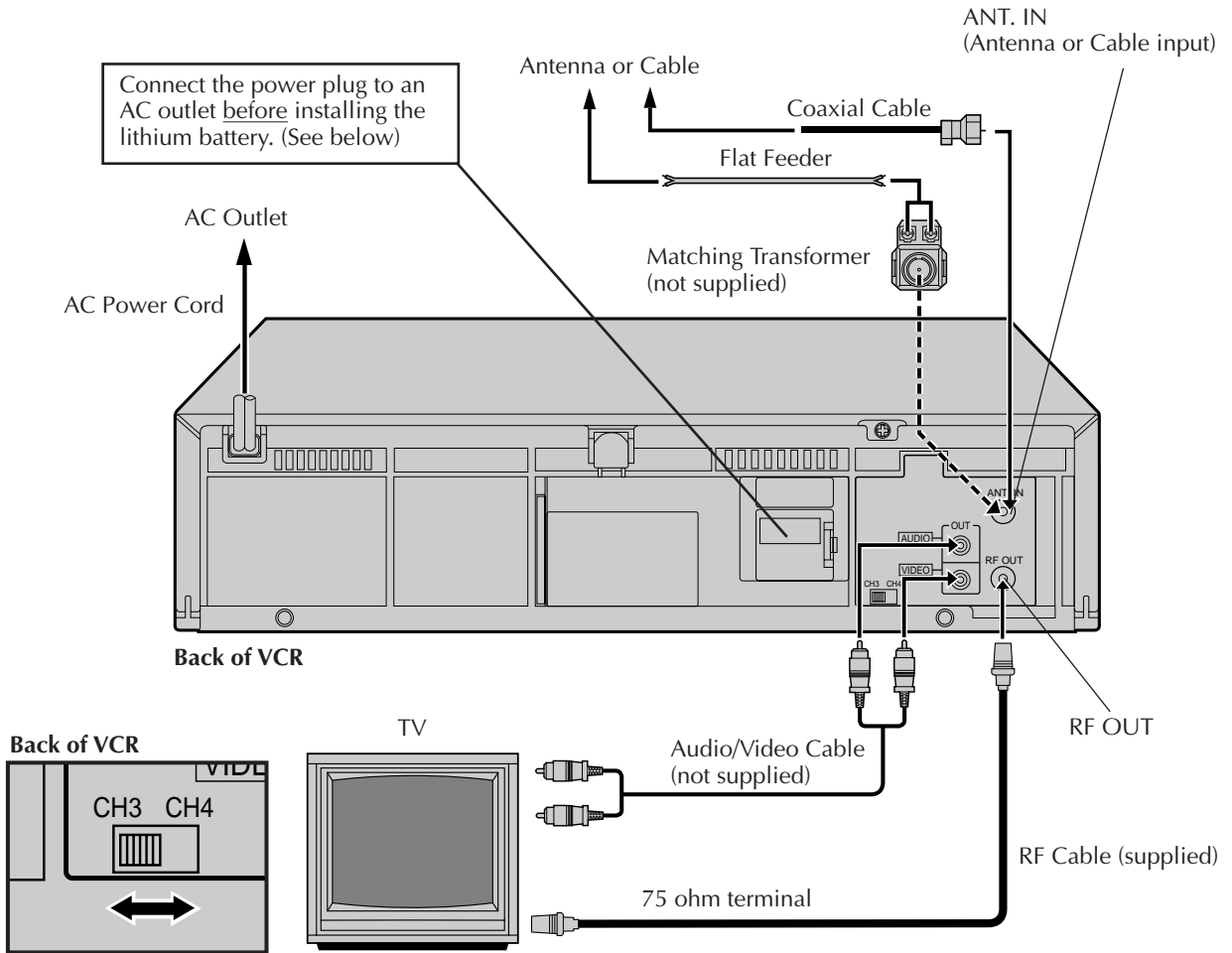

Be sure to connect the power plug to an AC outlet first before installing the lithium battery; otherwise, the battery's service life will be drastically shortened.

Installing/Removing the lithium battery

- 1 Make sure that the power plug is connected to an AC outlet and turn off the VCR power.
- 2 Open the battery cover while pressing the release tab as illustrated.
- 3 Insert a lithium battery with the plus (+) side facing you and push it in.
 - To remove the lithium battery, press the latch (A) downward using a pointed non-metallic object, then pull out the lithium battery.
- 4 Close the battery cover until it clicks in place.

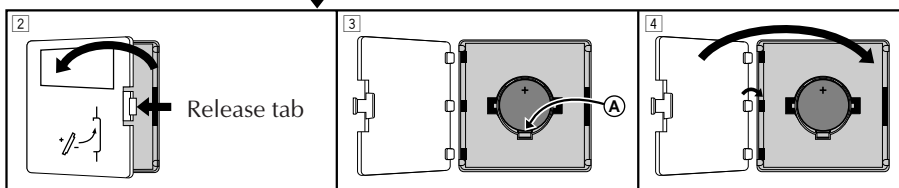
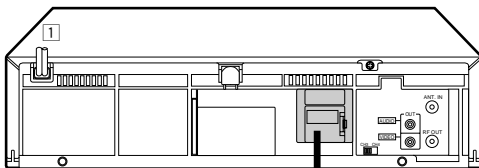

1 CHECK CONTENTS

Make sure the package contains all of the accessories listed in "SPECIFICATIONS" (☞ pg. 37).

2 SITUATE VCR

Place the VCR on a stable, horizontal surface.

3 CONNECT VCR TO TV

The connection method you use depends on the type of TV you have.

RF Connection

- *To Connect To A TV With NO AV Input Terminals . . .*
 - a- Disconnect the TV antenna from the TV.
 - b- Connect the TV antenna cable to the ANT. IN jack on the rear of the VCR.
 - c- Connect the supplied RF cable between the RF OUT jack on the rear of the VCR and the TV's antenna terminal. Select channel 3 or 4 on your TV corresponding to the CH3 – CH4 switch setting on the back of the VCR.

AV Connection

- *To Connect To A TV With AV Input Terminals . . .*
 - a- Connect the antenna, VCR and TV as shown in the illustration.
 - b- Connect an Audio/Video Cable between the AUDIO OUT and VIDEO OUT jacks on the rear of the VCR and the AV IN jacks on the TV. Select video input mode or A/V input mode on your TV. Refer to the TV Instruction Manual.

If your TV has AUDIO IN L (MONO) and R connectors, connect the VCR to the L (MONO) connector.

4 CONNECT VCR TO POWER SOURCE

Connect the power plug to an AC outlet.

5 FINAL PREPARATION FOR USE

Select the VCR channel (3 or 4) by setting the switch on the rear of the VCR as shown in the illustration. Perform Plug & Play (☞ pg. 6 and 7).

NOTES:

- *The VCR channel is the channel on the TV which will receive the audio and video signals from the VCR. The VCR's CH3-CH4 switch, on the back of the VCR, sets the VCR channel to CH3 or CH4.*
- *The CH3-CH4 switch is preset to the CH3 position. Set to CH4 if CH3 is used for broadcasting in your area and set the channel on the TV to correspond to the VCR's CH3-CH4 switch setting.*
- *If RF connection to TV is used, when switching from VCR to TV mode and from TV to VCR it may be necessary to issue a CH UP and then CH DOWN on TV to obtain a good quality picture.*
- *Even if you are using AV cables to connect your VCR to your TV, you must also connect it using the RF cable. This will ensure that you can record one show while watching another (☞ pg. 23).*
- *For full identification of the VCR's rear panel, refer to the Index (REAR VIEW ☞ pg. 35).*

Plug & Play

Before starting...

- Connect the TV antenna cable to the ANT. IN jack on the VCR and plug the power cord into the AC outlet.
- Turn on the TV and select the VCR channel 3 or 4 (or AV mode).

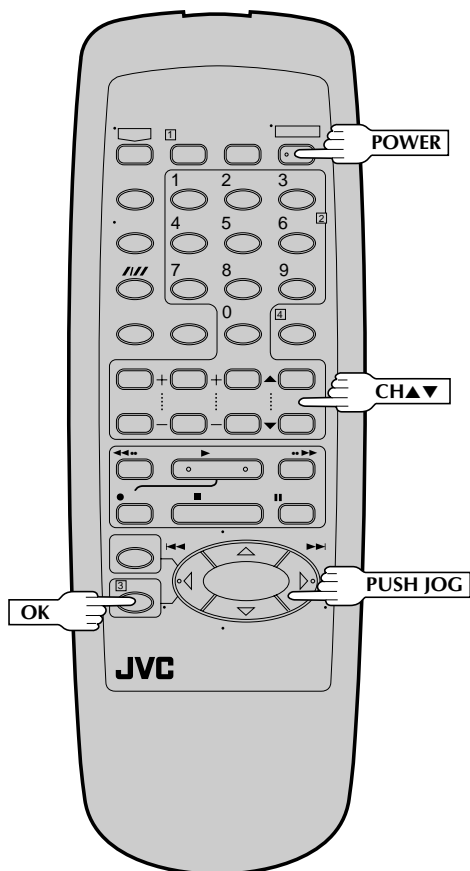
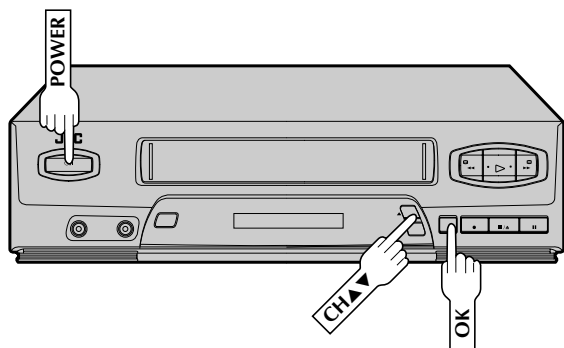

The Plug & Play function simplifies installation by guiding you through the procedures of setting the language, clock and tuner channels — simply follow the on-screen menus that appear when the **POWER** button is first pressed to power on the VCR after you connect the power plug to an AC outlet.

IMPORTANT

- Don't press any buttons on the VCR or remote control that are not directly related to the steps you are performing while Plug & Play is in progress.
- If you perform Plug & Play successfully during installation, there's no need to separately perform the Language Select, Clock Set or Channel Set procedures, but if adjustments become necessary they can be performed as follows:
 - To change the selected language ☞ pg. 8
 - To reset or adjust the time ☞ pg. 9
 - To confirm the summer time adjust ☞ pg. 11
 - To add/delete channels manually ☞ pg. 13
 - To reset the tuner after moving to a different location ☞ pg. 12

PERFORM PLUG & PLAY SETUP

Press **POWER**.

- The Language Select screen appears.

SELECT LANGUAGE

Move the highlight bar (arrow) to your desired language "ENGLISH" or "ESPAÑOL" by pressing **CH ▲▼** or **PUSH JOG ▲▽**, then press **OK** or **PUSH JOG ▷**.

SELECCION DE IDIOMA

ENGLISH
→ ESPAÑOL

ELEGIR CON (▲,▼) Y (OK)
PRESIONE (MENU) P/TERMINAR

- The Clock Set screen appears.

SET TIME

Press **CH ▲▼** or **PUSH JOG ▲▽** to set the hour, then press **OK** or **PUSH JOG ▷**.

- Press and hold either button to delay or advance the time by 30 minutes.

CLOCK SET

TIME DATE YEAR
--:-- 1/ 1 98

PRESS (▲,▼), THEN (OK)
PRESS (MENU) TO END

SET DATE

Press **CH ▲▼** or **PUSH JOG ▲▽** to set the date, then press **OK** or **PUSH JOG ▷**.

- Press and hold either button to change the date by 15 days.

SET YEAR

Press **CH ▲▼** or **PUSH JOG ▲▽** to set the year.

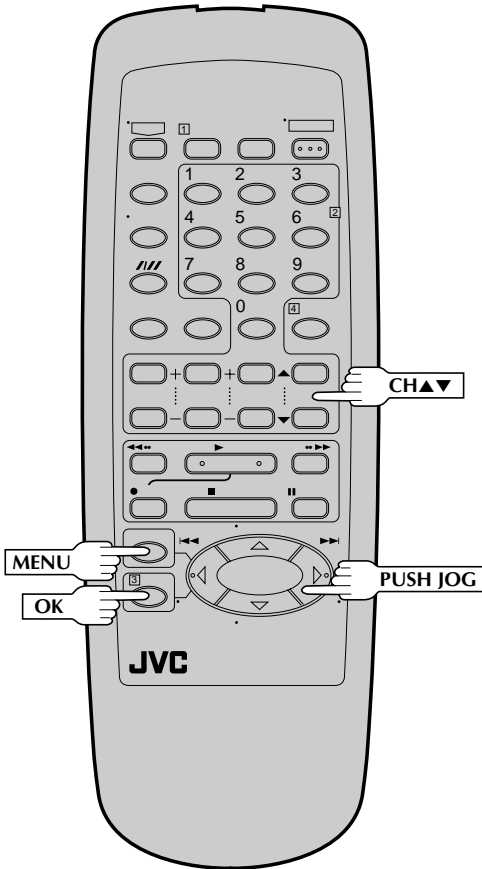
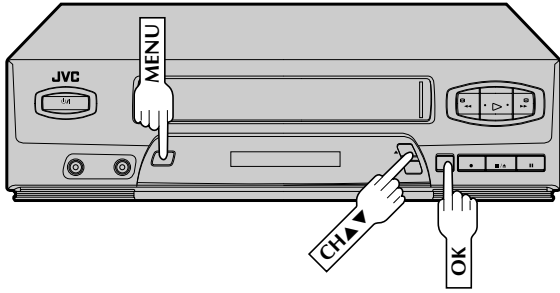

6 START AUTO CHANNEL SET

Press **MENU**.

- Receivable channels in your area are automatically assigned to the **CH ▲▼** buttons, and non-receivable channels are skipped.
- If the tuner channels have been set properly "SCAN COMPLETED" will be displayed on the screen. If "NO SIGNAL" is displayed on the screen, make sure that the antenna cable is connected to the VCR properly and press **OK** or **PUSH JOG ▷**. The VCR will try Auto Channel Set again.

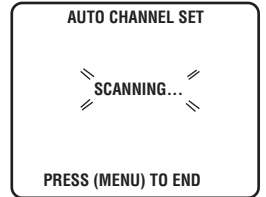

7 RETURN TO NORMAL SCREEN

Press **MENU**.

Language

Turn on the TV and select the VCR channel 3 or 4 (or AV mode).

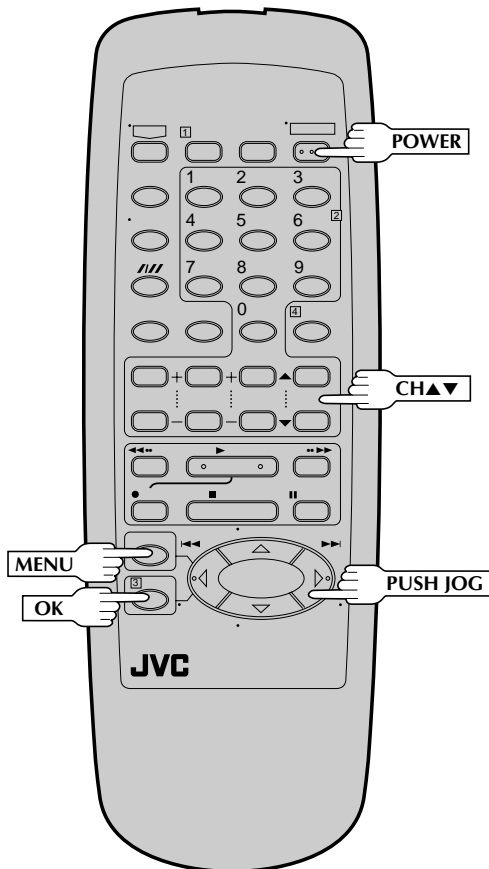
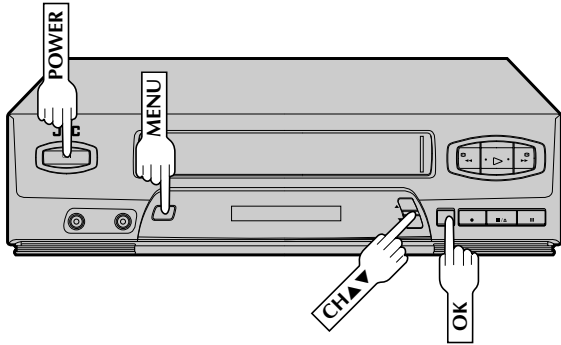

This VCR offers you the choice to view on-screen messages in Spanish or English (not including messages superimposed on the TV picture). Select the desired language using this procedure. The default setting is "ESPAÑOL".

1 TURN ON THE VCR

Press **POWER**.

2 ACCESS MAIN MENU SCREEN

Press **MENU**.

3 ACCESS INITIAL SET SCREEN

On the Main Menu screen, move the highlight bar (arrow) to "AJUSTE INICIAL" by pressing **CH ▲▼** or **PUSH JOG ▲▼**, then press **OK** or **PUSH JOG ▷**.

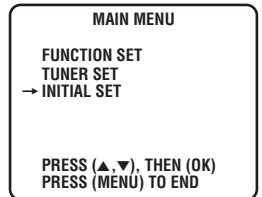

4 SELECT LANGUAGE

Move the highlight bar (arrow) to "IDIOMA" by pressing **CH ▲▼** or **PUSH JOG ▲▼**, then press **OK** or **PUSH JOG ▷** to select the desired language.

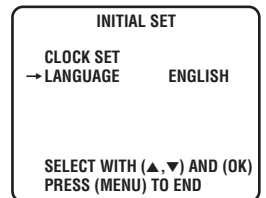

5 RETURN TO NORMAL SCREEN

Press **MENU**.

Clock

Turn on the TV and select the VCR channel 3 or 4 (or AV mode).

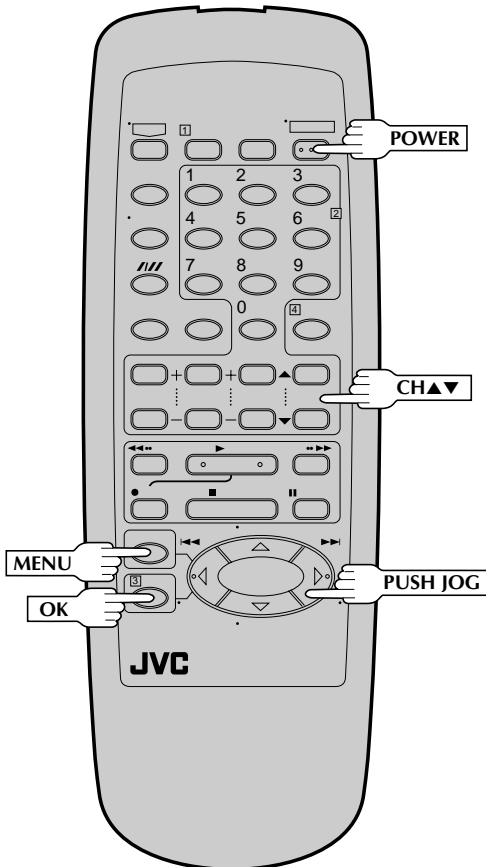
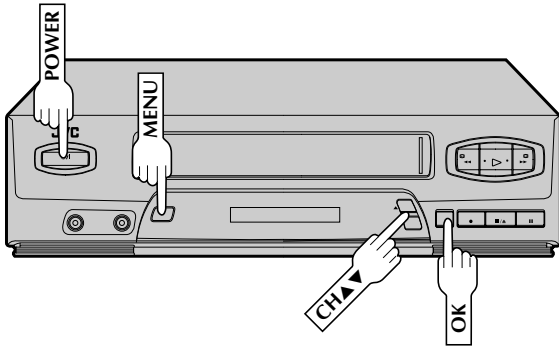

1 TURN ON THE VCR

Press **POWER**.

2 ACCESS MAIN MENU SCREEN

Press **MENU**.

3 ACCESS INITIAL SET SCREEN

On the Main Menu screen, move the highlight bar (arrow) to "INITIAL SET" by pressing **CH ▲▼** or **PUSH JOG ▲▼**, then press **OK** or **PUSH JOG ▷**.

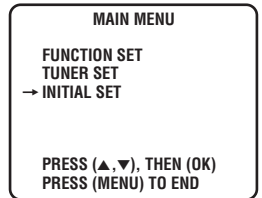

4 ACCESS CLOCK SET SCREEN

Move the highlight bar (arrow) at the Initial Set screen to "CLOCK SET" by pressing **CH ▲▼** or **PUSH JOG ▲▼**, then press **OK** or **PUSH JOG ▷**.

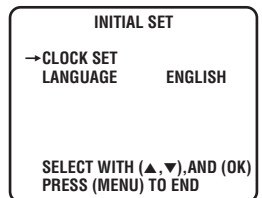

5 SET TIME

Press **CH ▲▼** or **PUSH JOG ▲▼** until the desired time appears, then press **OK** or **PUSH JOG ▷**.

- Press and hold **CH ▲▼** or **PUSH JOG ▲▼** to change the time by 30 minutes.

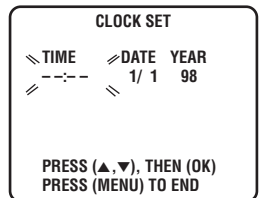

CONTINUED ON THE NEXT PAGE

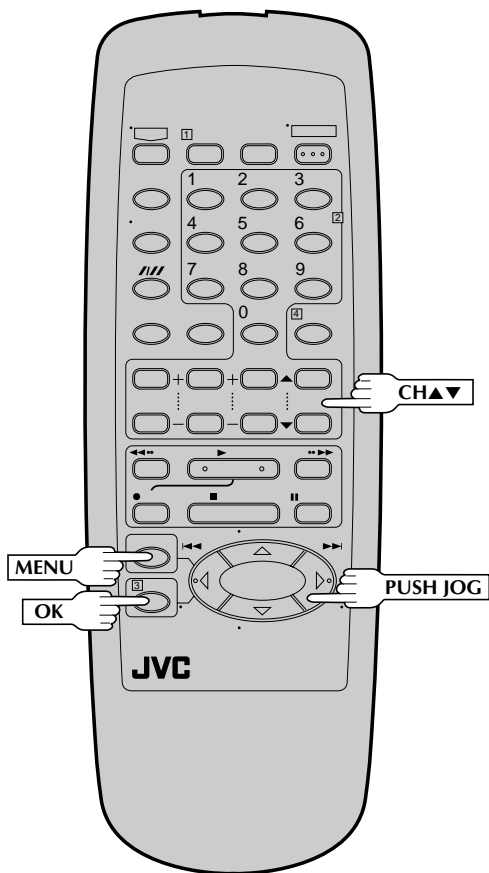
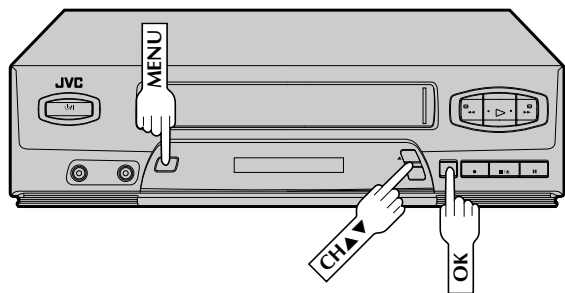

6

SET DATE

Press **CH ▲▼** or **PUSH JOG Δ∇** until the desired date appears, then press **OK** or **PUSH JOG ▷**.

- Press and hold **CH ▲▼** or **PUSH JOG Δ∇** to change the date by 15 days.

7

SET YEAR

Press **CH ▲▼** or **PUSH JOG Δ∇** until the desired year appears.

8

START CLOCK

Press **MENU** and normal screen appears.

- Summer Time (Daylight saving time) adjust is automatically activated. (See page 11.)

To Make Corrections While Setting

Press **OK** or **PUSH JOG ▷** until the item you want to change blinks, then press **CH ▲▼** or **PUSH JOG Δ∇**.

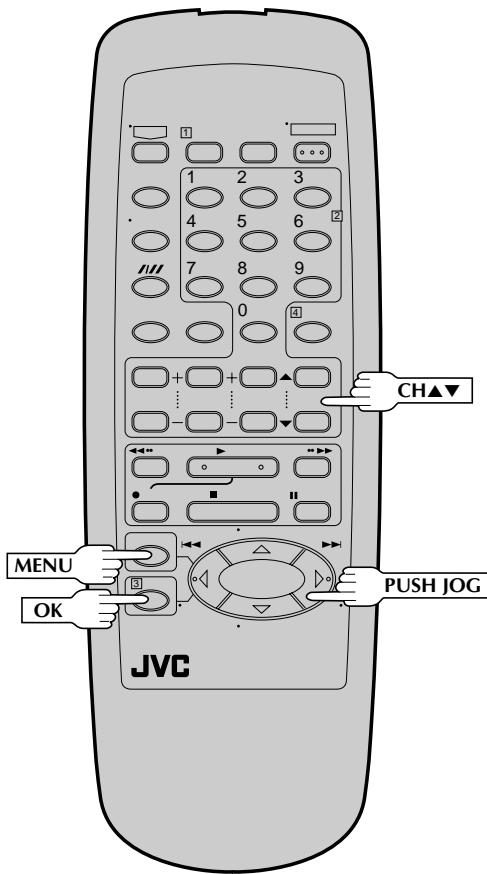
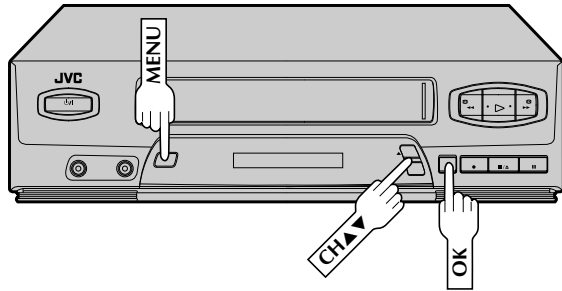

Summer Time (Daylight saving time)

Once you have set the clock, whenever your local time enters Summer Time or goes back to regular time, you can easily make the 1-hour time adjustment using this function.

ACCESS MAIN MENU SCREEN

Press MENU.

ACCESS INITIAL SET SCREEN

On the Main Menu screen, move the highlight bar (arrow) to "INITIAL SET" by pressing CH ▲▼ or PUSH JOG Δ▽, then press OK or PUSH JOG ▷.

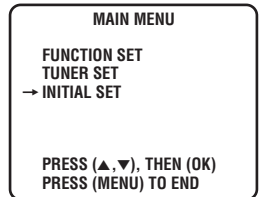

ACCESS CLOCK SET SCREEN

Move the highlight bar (arrow) at the Initial Set screen to "CLOCK SET" by pressing CH ▲▼ or PUSH JOG Δ▽, then press OK or PUSH JOG ▷.

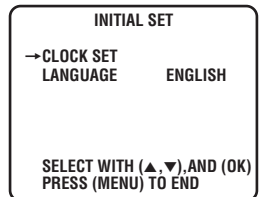

CONFIRM SUMMER TIME ADJUST SCREEN

"SUMMER TIME ADJUST" appears while the hour digits are blinking.

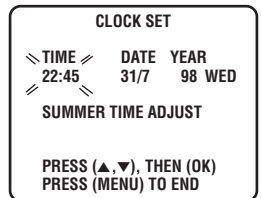

MAKE THE 1-HOUR TIME ADJUSTMENT

Add or subtract 1 hour at the Summer Time Adjust screen by pressing CH ▲▼ or PUSH JOG Δ▽, then press OK or PUSH JOG ▷.

RETURN TO NORMAL SCREEN

Press MENU.

Tuner

Turn on the TV and select the VCR channel 3 or 4 (or AV mode).

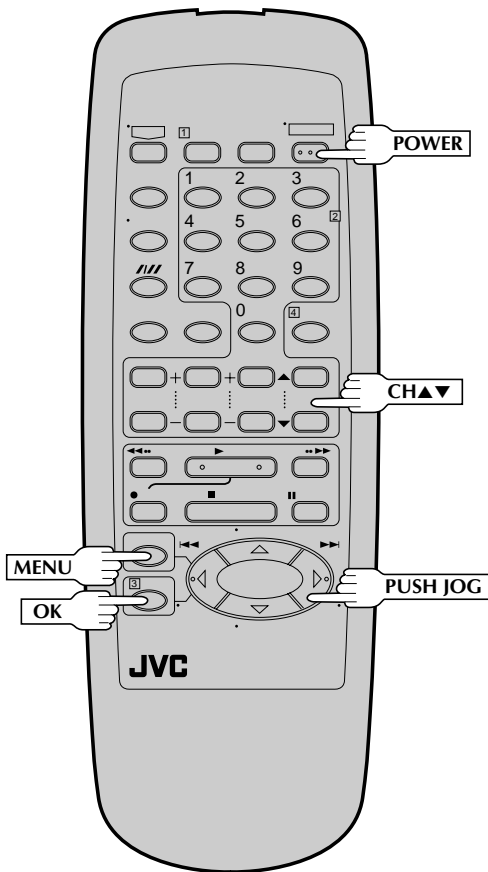
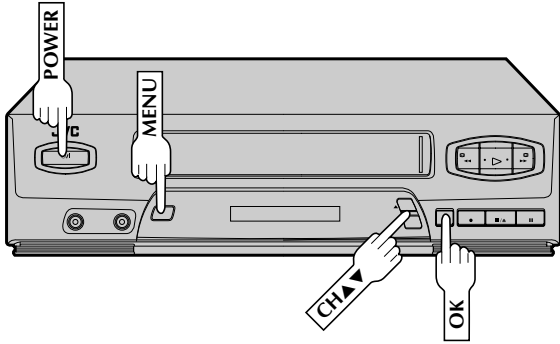

INFORMATION

The VCR detects the band (TV or CATV) and selects the correct band automatically during Auto Channel Set. The selected band will be displayed on the right side of "BAND" on the Tuner Set screen.

Set Receivable Channels

1 TURN ON THE VCR

Press **POWER**.

2 ACCESS MAIN MENU SCREEN

Press **MENU**.

3 ACCESS TUNER SET SCREEN

Move the highlight bar (arrow) to "TUNER SET" by pressing **CH ▲▼** or **PUSH JOG Δ∇**, then press **OK** or **PUSH JOG ▷**.

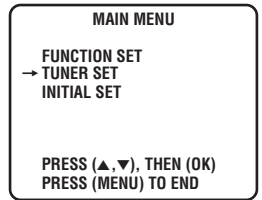

4 PERFORM AUTO CHANNEL SET

Move the highlight bar (arrow) to "AUTO CHANNEL SET" by pressing **CH ▲▼** or **PUSH JOG Δ∇**, then press **OK** or **PUSH JOG ▷**.

- Receivable channels in your area are automatically assigned to the **CH ▲▼** buttons, and non-receivable channels are skipped.

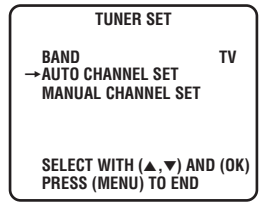

NOTES:

- At the end of Auto Channel Set, "SCAN COMPLETED" appears on screen.
- If the scan was unsuccessful, "SCAN COMPLETED-NO SIGNAL-" appears on screen. Check the connections and start again.

5 RETURN TO NORMAL SCREEN

Press **MENU**.

NOTE:

If the VCR's memory backup expires because of a power failure, set receivable channels again.

Add Or Delete A Channel

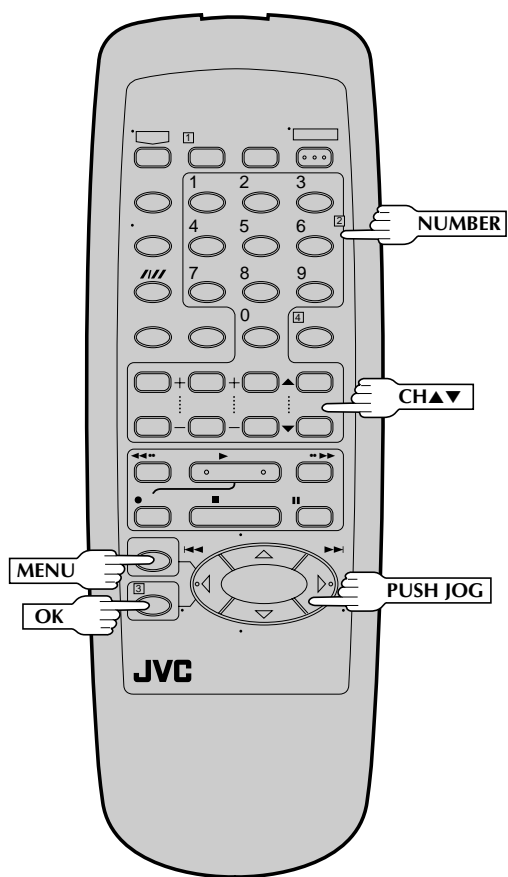
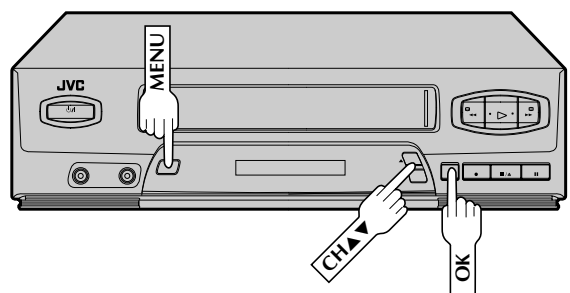

- 1** **ACCESS MAIN MENU SCREEN**
Press **MENU**.

- 2** **ACCESS TUNER SET SCREEN**
Move the highlight bar (arrow) to "TUNER SET" by pressing **CH ▲▼** or **PUSH JOG ▲▽**, then press **OK** or **PUSH JOG ▷**.

- 3** **ACCESS MANUAL CHANNEL SET SCREEN**
Move the highlight bar (arrow) to "MANUAL CHANNEL SET" by pressing **CH ▲▼** or **PUSH JOG ▲▽**, then press **OK** or **PUSH JOG ▷**.

TUNER SET

BAND TV
 AUTO CHANNEL SET
 → MANUAL CHANNEL SET

SELECT WITH (▲,▽) AND (OK)
 PRESS (MENU) TO END

- 4** **ADD OR SKIP DESIRED CHANNEL**
Input the channel number using the **NUMBER** keys or by pressing **CH ▲▼** or **PUSH JOG ▲▽**, then press **OK** or **PUSH JOG ▷** to set to "ADD" or "SKIP" as required. Repeat for each channel you want to add or skip.

MANUAL CHANNEL SET

(SATV)
 CH 45 ADD

PRESS NUMBER KEY (0-9)
 OR (▲,▽), THEN (OK)
 PRESS (MENU) TO END

- 5** **RETURN TO NORMAL SCREEN**
Press **MENU**.

Simple Playback

Turn on the TV and select the VCR channel 3 or 4 (or AV mode).

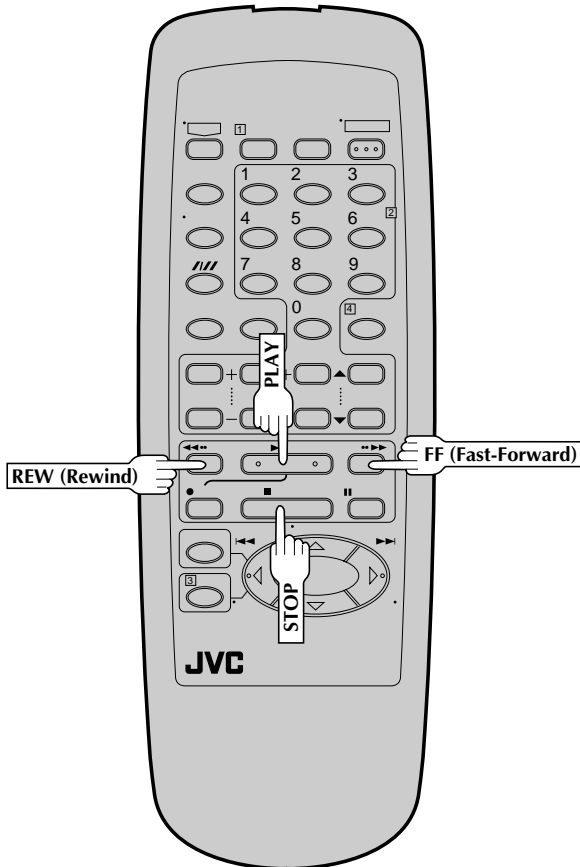
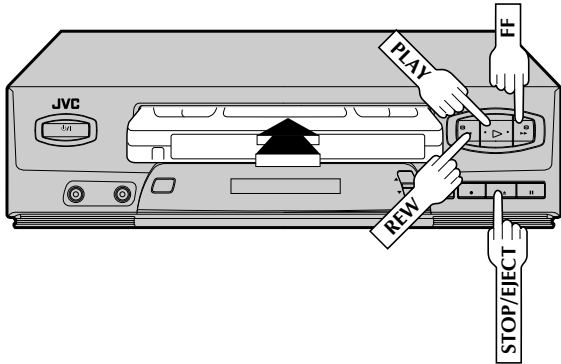

1 LOAD A CASSETTE

Make sure the window side is up, the rear label side is facing you and the arrow on the front of the cassette is pointing towards the VCR. Don't apply too much pressure when inserting.

- The VCR's power comes on automatically.
- The counter is automatically reset to "0:00:00".
- If the cassette's record safety tab has been removed, playback begins automatically.

2 FIND PROGRAM START POINT

If the tape is advanced past the start point, press **REW**. To go forward, press **FF**.

3 START PLAYBACK

Press **PLAY**. "B.E.S.T. PICTURE SYSTEM" appears on the screen (when B.E.S.T. is set to "ON"  pg. 20).

4 STOP PLAYBACK

Press **STOP** or **STOP/EJECT**. Then press **STOP/EJECT** to remove the cassette.

Usable cassettes

VHS
T-30 (ST-30**)
T-60 (ST-60**)
T-90
T-120 (ST-120**)
T-160 (ST-160**)
ST-210**

VHS-C*
TC-20 (ST-C20**)
TC-30 (ST-C30**)
TC-40 (ST-C40**)

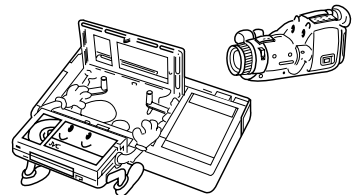

* Compact VHS camcorder recordings can be played on this video recorder. Simply place the recorded cassette into a VHS Cassette Adapter and it can be used just like any VHS cassette.

** This video recorder can record on regular VHS and Super VHS cassettes. However, it will record regular VHS signals only.

Simple Recording

Turn on the TV and select the VCR channel 3 or 4 (or AV mode).

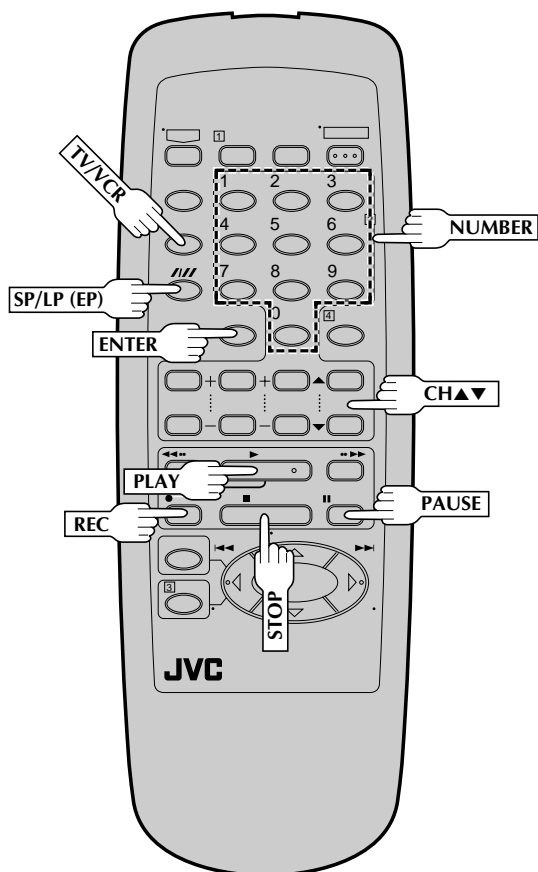
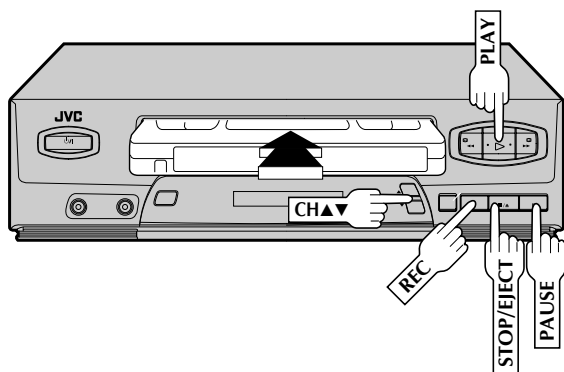

1 LOAD A CASSETTE

Make sure the record safety tab is intact. If not, cover the hole with adhesive tape before inserting the cassette.

2 SELECT RECORDING CHANNEL

Press **CH ▲▼**. Or press the appropriate **NUMBER** keys, then press **ENTER**. (The channel changes after a few seconds whether you press **ENTER** or not.)

- If you use the RF connection, by pressing the **TV/VCR** button, select VCR mode to view the program to be recorded.

3 SET TAPE SPEED

Press **SP/LP (EP)** to set the recording speed.

4 START RECORDING

Press and hold **REC** and press **PLAY** on the remote control, or press **REC** on the VCR's front panel.

B.E.S.T. takes place at the beginning of both the first SP and the first LP (or EP) recording after inserting the cassette (when B.E.S.T. is set to "ON", pg. 20).

5 PAUSE/RESUME RECORDING

Press **PAUSE**. Press **PLAY** to resume recording.

- During record pause, you can change the recording channel by using the **CH ▲▼** buttons or **NUMBER** keys.

B.E.S.T. will not take place if the tape speed is changed while in record pause mode.

6 STOP RECORDING

Press **STOP** or **STOP/EJECT**. Then press **STOP/EJECT** to remove the cassette.

Recording Resume Function

If there is a power outage during recording (or Instant Timer Recording or timer recording), the recording will resume automatically when power is restored to the VCR.

Accidental erasure prevention

- To prevent accidental recording on a recorded cassette, remove its record safety tab. To record on it later, cover the hole with adhesive tape.

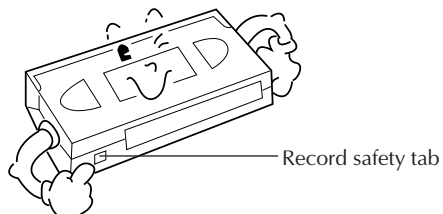

Playback Features

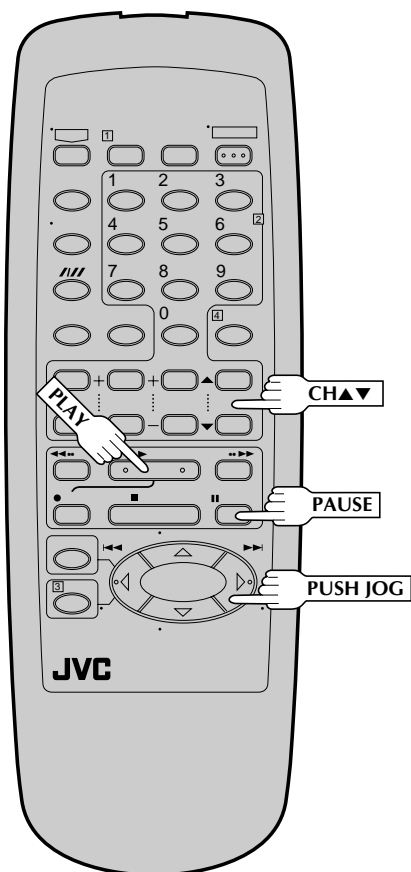
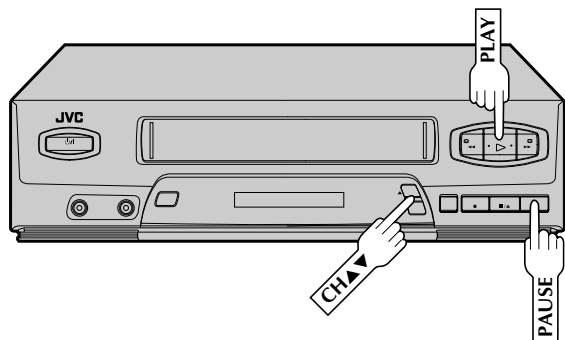

Still Picture/Frame-By-Frame Playback

1 PAUSE DURING PLAYBACK

Press **PAUSE**. If there is vertical jitter, use the **CH ▲** or **▼** button to correct the picture.

2 ACTIVATE FRAME-BY-FRAME PLAYBACK

Press **PAUSE** repeatedly to advance one frame at a time.

OR

Press **PUSH JOG ►►** repeatedly for forward frame-by-frame playback or **PUSH JOG ◄◄** repeatedly for reverse frame-by-frame playback.

To resume normal playback, press **PLAY**.

Slow Motion/Reverse Slow Motion

1 ACTIVATE SLOW-MOTION PLAYBACK

For hands-free slow-motion, press and release **PUSH JOG ◄◄** during playback to decrease speed in the forward direction. Continue to press and release **PUSH JOG ◄◄** to select the reverse slow motion, reverse play and reverse search modes.

OR

During still picture, press and hold **PUSH JOG ►►** for forward slow motion, or press and hold **PUSH JOG ◄◄** for reverse slow motion. Release to return to still picture.

OR

For forward slow motion during still picture, press and hold **PAUSE** for more than 2 seconds. Press **PAUSE** again to return to still picture.

To resume normal playback, press **PLAY**.

Variable-Speed Search/Reverse Motion Playback

1 ACTIVATE VARIABLE-SPEED SEARCH

During playback, repeatedly press and release **PUSH JOG ◄◄** or **►►** to select the search speed.

- To increase the speed in the forward direction, press and release **►►** repeatedly to select the various forward search modes.
- To decrease the speed in the forward direction, press and release **◄◄**.
- To play in reverse slow motion, and in reverse play mode, continue to press **◄◄** repeatedly after selecting all the forward slow motion modes.

To resume normal playback, press **PLAY**.

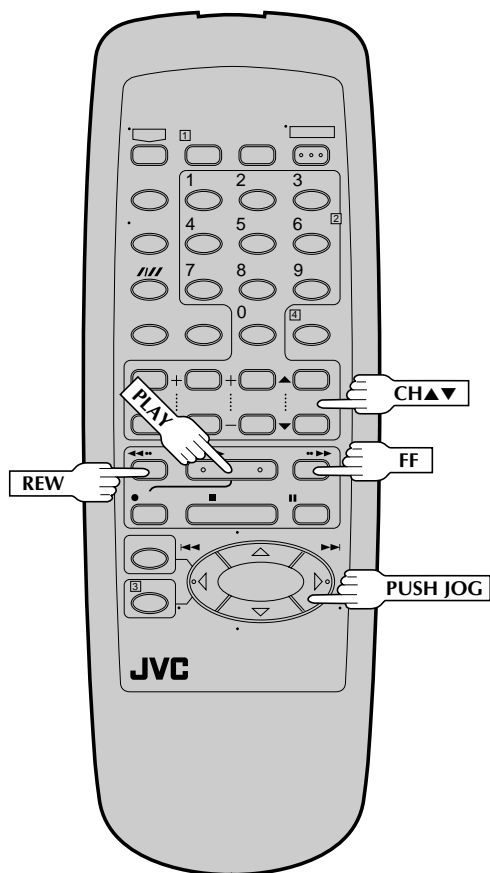
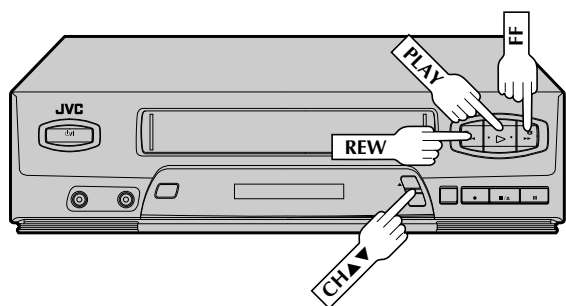

High-Speed Search

1 ACTIVATE HIGH-SPEED SEARCH

During playback or still, press **FF** for forward high-speed search, or **REW** for reverse high-speed search.

To resume normal playback, press **PLAY**.

NOTE:

For short searches, during playback or still, press and hold **FF** or **REW** for over 2 seconds. When released, normal playback resumes.

Index Search

Index codes are placed on the tape at the start of each recording. You can find and automatically play back from the start of any recording using the Index Search function.

1 START SEARCH

While the tape is stopped, press **PUSH JOG** ◀◀ or ▶▶.

2 ACCESS DISTANT CODE

To access a recording 2–9 index codes away, press **PUSH JOG** ◀◀ or ▶▶ repeatedly until the correct number is displayed on screen (only if **SUPERIMPOSE** is set to ON (pg. 19)). Playback begins automatically when the desired recording is located.

- If necessary press **REW** or **FF** when play starts to search visually to find the very beginning of the desired program.

NOTE:

An index code is not placed on the tape when recording is paused and then resumed.

Manual Tracking

Once playback begins, the VCR's automatic tracking function is engaged. If tracking noise appears in the picture, you can override this and make the adjustment manually.

1 ENGAGE MANUAL TRACKING MODE

During playback, press the **CH** ▲ and ▼ buttons on the VCR's front panel simultaneously to cancel the automatic tracking mode and enable manual tracking adjust.

2 ADJUST MANUAL TRACKING

Press **CH** ▲ or ▼ on the VCR's front panel or remote control. Press briefly for fine adjust, or press and hold for coarse adjust. Watch the screen and continue adjusting until optimum picture and sound quality are achieved.

3 RE-ENGAGE AUTOMATIC TRACKING

Press the **CH** ▲ and ▼ buttons on the VCR's front panel simultaneously.

- When automatic tracking is re-engaged, B.E.S.T. is automatically activated.

NOTES:

- To obtain a noiseless still picture it may be necessary to adjust tracking in slow playback and then engage Pause.
- Manual tracking is possible during hands-free slow-motion. During hands-free slow-motion playback, simply press **CH** ▲ or ▼ on the VCR's front panel or remote to adjust tracking.

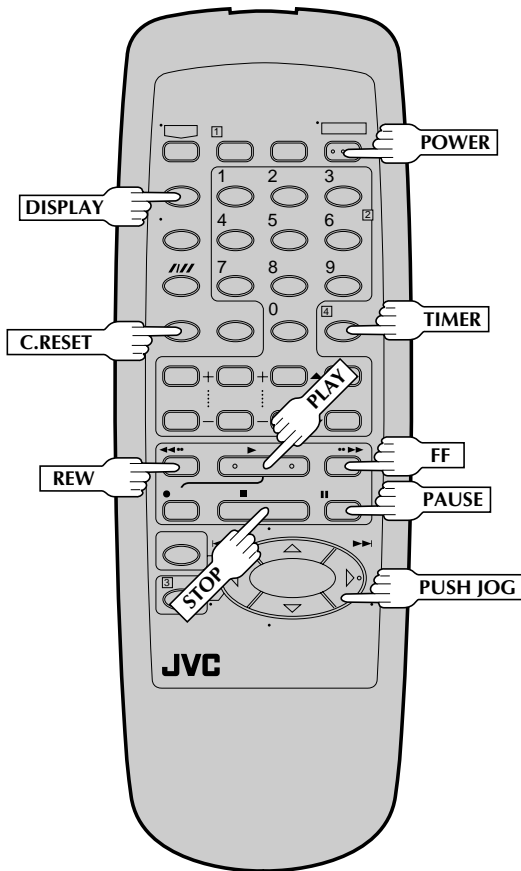
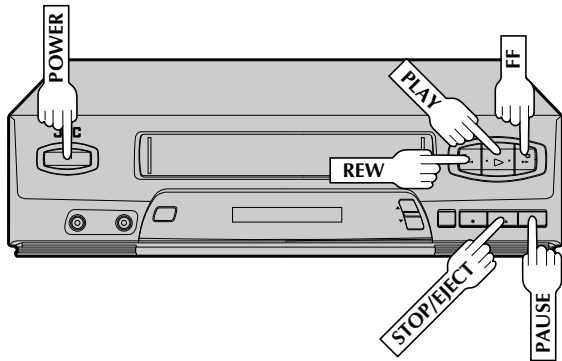

Repeat Playback

START REPEAT

1

Press and hold **PLAY** (until "▶" blinks on the front display panel) during playback, then release.



- The entire tape is played back 50 times.

STOP REPEAT

2

To stop, press **STOP** or **STOP/EJECT** at any time.

NOTE:

Pressing **PLAY**, **REW**, **FF**, **PAUSE** or **PUSH JOG** ◀◀ or ▶▶ also stops Repeat Playback.

Counter Reset

RESET COUNTER TO ZERO

1

Press **C.RESET**.

NOTE:

By pressing the **DISPLAY** button, you can change the display to show the counter reading, channel number or clock time. (Channel number is not displayed during playback.)

Tape Position Indicator

The Tape position indicator appears on screen when, from the stop mode, you press **FF** or **REW**, or perform an Index Search. The position of "■" in relation to "B" (Beginning) or "E" (End) shows you where you are on the tape.

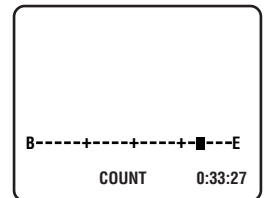

NOTES:

- "SUPERIMPOSE" must be set to "ON", or the indicator will not appear (pg. 19).
- It may take a few seconds for the Tape Position Indicator to be displayed.

Next-Function Memory

The Next Function Memory "tells" the VCR what to do after rewinding. Before continuing, ensure that the VCR is in stop mode.

- a- For Automatic Start Of Playback After Tape Rewind . . .
... press **REW**, then press **PLAY** within 2 seconds.
- b- For Automatic Power Off After Tape Rewind . . .
... press **REW**, then press **POWER** within 2 seconds.
- c- For Automatic Timer Standby After Tape Rewind . . .
... press **REW**, then press **TIMER** within 2 seconds.

NOTE:

It is not possible to select the Automatic Timer functions if the cassette's record safety tab is removed.

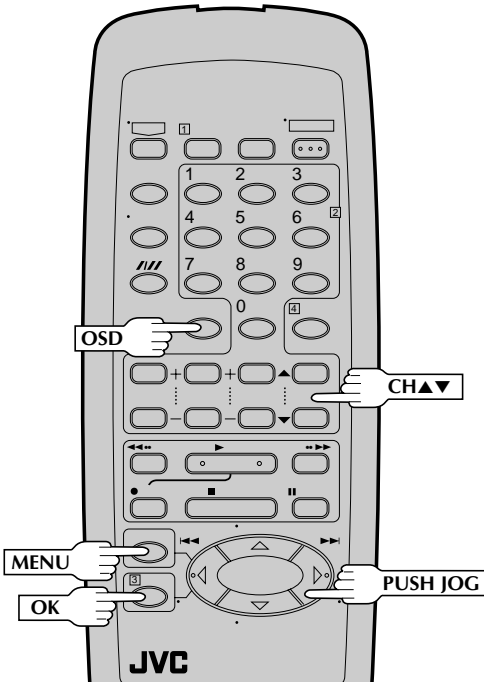
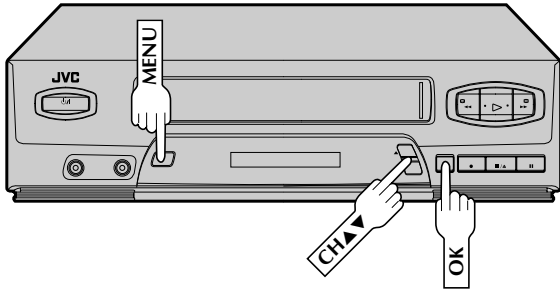

Superimpose

This function, switchable between ON and OFF, determines whether or not operational indicators will appear on screen.

1 ACCESS MAIN MENU SCREEN

Press MENU.

2 ACCESS FUNCTION SET SCREEN

Move the highlight bar (arrow) to "FUNCTION SET" by pressing CH ▲▼ or PUSH JOG ▲▼, then press OK or PUSH JOG ▷.

3 SELECT SUPERIMPOSE SET MODE

Move the highlight bar (arrow) to "SUPERIMPOSE" by pressing CH ▲▼ or PUSH JOG ▲▼, then press OK or PUSH JOG ▷ to select the desired mode:

FUNCTION	
AUTO TIMER	OFF
→ SUPERIMPOSE	ON
AUTO SP→LP TIMER	OFF
B.E.S.T.	ON
VIDEO SYSTEM	AUTO

SELECT WITH (▲, ▼) AND (OK) PRESS (MENU) TO END

a- Select "ON" if you want the superimposed operational indications on the TV screen.

b- Select "OFF" if you do not want the superimposed operational indications on the screen.

4 RETURN TO NORMAL SCREEN

Press MENU.

4

NOTES:

- If you engage the Record Pause mode, RECORD PAUSE is displayed regardless of the Superimpose mode setting.
- If you select a channel on which no signal is received, the channel number is displayed regardless of the Superimpose mode setting.

To recall an indication

- 1 Press OSD.
 - All indications corresponding to the current status are displayed for 5 seconds. After that, the counter information and RECORD PAUSE if in the Record Pause mode, are left displayed on the screen.
- 2 Press OSD again to clear the display.

The superimposed indication on the TV screen tells you what the VCR is doing.

Tuned-in channel or AUX(iliary) mode

When the channel is changed, the new channel is displayed on the screen for 5 seconds.

Clock time

Tape position indicator

Video system indicator

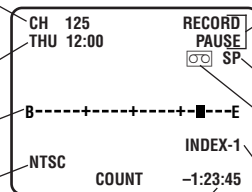

Counter reading

Operation mode

When the operation mode is changed, the new mode is displayed — RECORD (5 sec.), PLAY (5 sec.), FF/REW (5 sec. when engaged from Stop mode), RECORD PAUSE (for as long as Pause is engaged), and ITR **:*(5 sec.).

Tape speed indication

"Cassette Loaded" mark

When a cassette is loaded, the mark is displayed for 5 seconds. It blinks when the VCR's EJECT button is pushed.

INDEX indication

B.E.S.T. Picture System

Turn on the TV and select the VCR channel 3 or 4 (or AV mode).

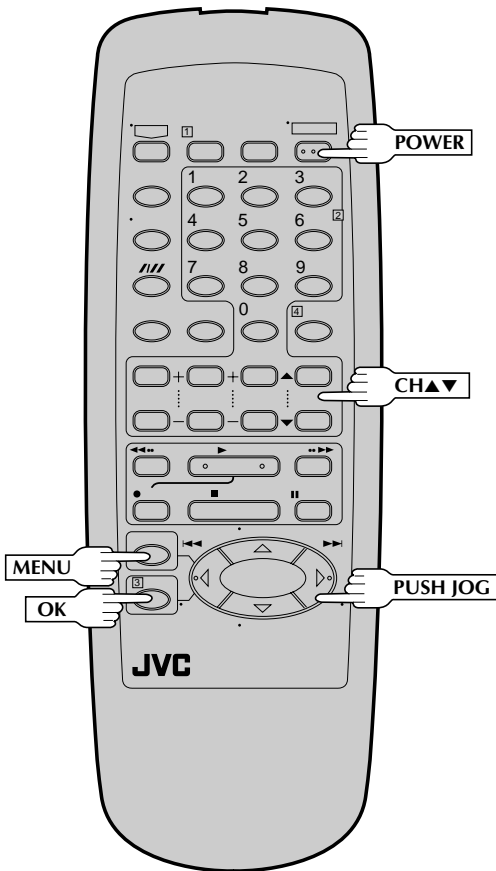
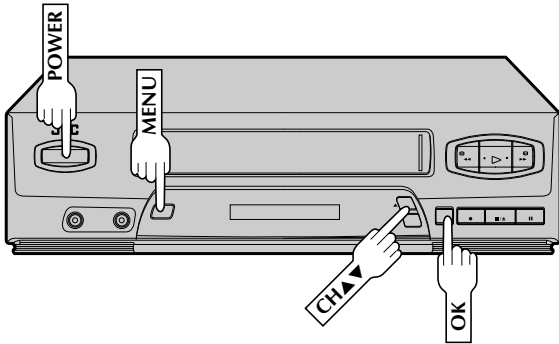

The B.E.S.T. (Biconditional Equalized Signal Tracking) checks the condition of the tape during recording and playback, and compensates for poor reproduction to provide the best quality recording and playback pictures. *The default setting is "ON".

Preparation

1 TURN ON THE VCR

Press **POWER**.

2 ACCESS MAIN MENU SCREEN

Press **MENU**.

3 ACCESS FUNCTION SET SCREEN

Move the highlight bar (arrow) to "FUNCTION SET" by pressing **CH ▲▼** or **PUSH JOG ▲▼**, then press **OK** or **PUSH JOG ▷**.

MAIN MENU	
→ FUNCTION SET	
TUNER SET	
INITIAL SET	
PRESS (▲, ▼), THEN (OK)	
PRESS (MENU) TO END	

4 SELECT B.E.S.T. MODE

Move the highlight bar (arrow) to "B.E.S.T." by pressing **CH ▲▼** or **PUSH JOG ▲▼**, then press **OK** or **PUSH JOG ▷** to set to "ON" or "OFF".

FUNCTION	
AUTO TIMER	OFF
SUPERIMPOSE	ON
AUTO SP→LP TIMER	OFF
→B.E.S.T.	ON
VIDEO SYSTEM	AUTO
SELECT WITH (▲, ▼) AND (OK)	
PRESS (MENU) TO END	

NOTE:

When recording or when playing back tapes recorded on this VCR, set the B.E.S.T. to "ON".

5 RETURN TO NORMAL SCREEN

Press **MENU**.

Recording

Perform steps 1 – 3 on page 15 (“Simple Recording”) before continuing.

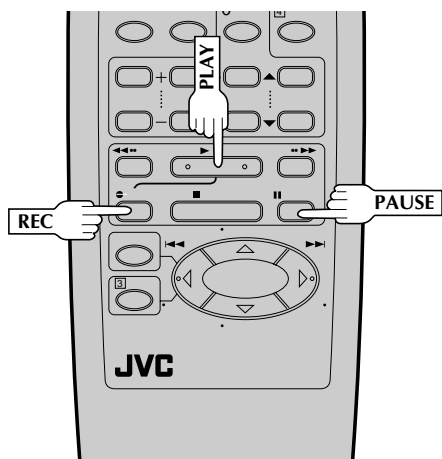
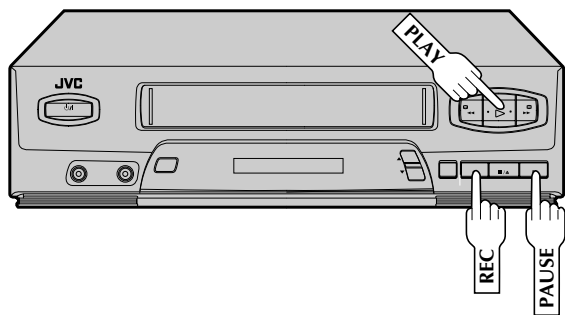

1 START RECORDING

Press and hold **REC** and press **PLAY** on the remote control, or press **REC** on the VCR's front panel.

- The VCR takes about 7 seconds to assess the quality of the tape in use, then recording begins with the picture level optimized.

DURING B.E.S.T.

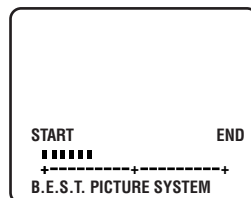

B.E.S.T. COMPLETE

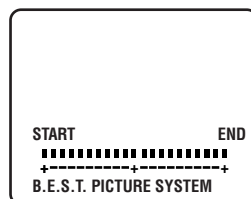

NOTES:

- B.E.S.T. occurs immediately prior to both the first SP and the first LP (or EP) recording after inserting the cassette. It does not take place during recording.
- In the case of timer recording, B.E.S.T. takes place for both SP and LP (or EP) before the first timer recording after inserting the cassette (regardless of the tape speed selected for that recording).
- Once the cassette is ejected, the B.E.S.T. data is canceled. The next time the cassette is used for recording, B.E.S.T. is re-performed.
- While B.E.S.T. is operative, the **PAUSE** button will not function.
- To display the B.E.S.T. Picture System, “SUPERIMPOSE” must be set to “ON” or the B.E.S.T. Picture System screen will not appear (☞ pg. 19).

Playback

The VCR assesses the quality of the tape once you start playback.

Perform steps 1 and 2 on page 14 (“Simple Playback”) before continuing.

1 START PLAYBACK

Press **PLAY**.

- The VCR adjusts the playback picture quality based on the quality of the tape in use.



NOTES:

- When using rental tapes, or tapes recorded on other VCRs, set “B.E.S.T.” in step 4 of the Preparation procedure to either “ON” or “OFF” as desired to give the best picture (☞ pg. 20).
- The B.E.S.T. Picture System screen only appears at the beginning of automatic tracking. Even though the screen doesn't appear after that, the B.E.S.T. function is operative.
- To display the B.E.S.T. Picture System screen, “SUPERIMPOSE” must be set to “ON” or the B.E.S.T. Picture System screen will not appear (☞ pg. 19).

ATTENTION

- As B.E.S.T. takes place before recording actually starts, there is a delay of about 7 seconds after **REC** and **PLAY** on the remote, or **REC** on the VCR's front panel, are pressed. To make sure you record the desired scene or program completely, first perform the following steps:
 - 1) Press and hold **PAUSE**, and press **REC** to engage the RECORD PAUSE mode.
 - The VCR then automatically checks the condition of the tape and, after about 7 seconds, re-enters RECORD PAUSE.
 - 2) Press **PLAY** to start recording.
- If you want to bypass B.E.S.T. and start recording right away, set “B.E.S.T.” to “OFF” in step 4 of the Preparation procedure (☞ pg. 20).

Video System

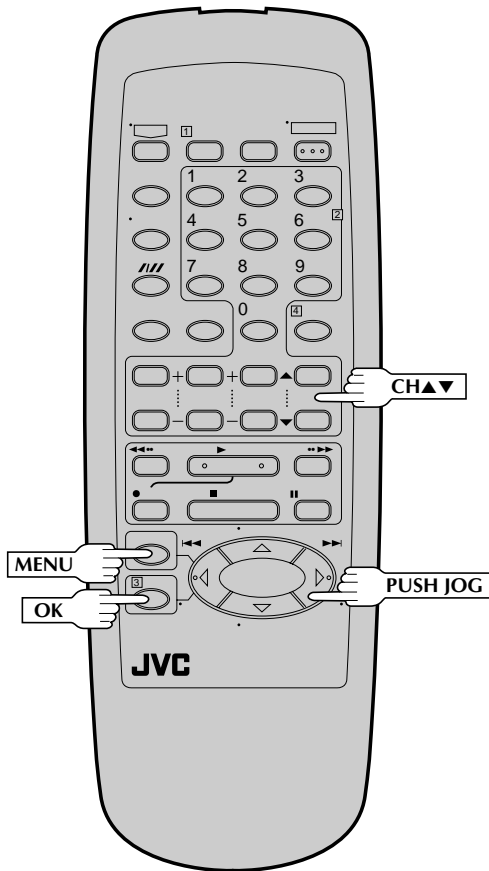
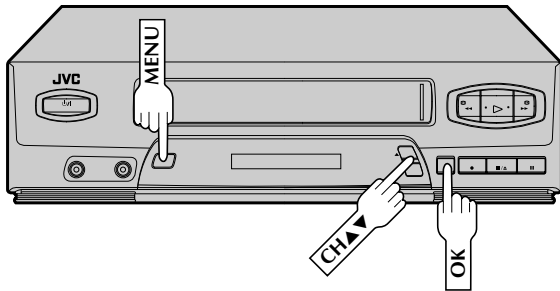

1 ACCESS MAIN MENU SCREEN

Press **MENU**.

2 ACCESS FUNCTION SET SCREEN

Move the highlight bar (arrow) to "FUNCTION SET" by pressing **CH ▲▼** or **PUSH JOG ▲▼**, then press **OK** or **PUSH JOG ▷**.

3 ACCESS VIDEO SYSTEM SET SCREEN

Move the highlight bar (arrow) to "VIDEO SYSTEM" by pressing **CH ▲▼** or **PUSH JOG ▲▼**, then press **OK** or **PUSH JOG ▷** to set to "AUTO", "PAL-N" or "NTSC".

FUNCTION	
AUTO TIMER	OFF
SUPERIMPOSE	ON
AUTO SP→LP TIMER	OFF
B.E.S.T.	ON
→VIDEO SYSTEM	AUTO

SELECT WITH (▲, ▼) AND (OK)
PRESS (MENU) TO END

4 RETURN TO NORMAL SCREEN

Press **MENU**.

MODE	WHEN YOU USE
AUTO mode (color signal)	Normally set to the "AUTO" position. AUTO mode detects the type of the received TV color system or the type of the video format of the tape to be played back automatically.
	When the tape cannot be detected automatically, the switch should be set manually.
NTSC mode	Use this mode when you playback an NTSC tape on an NTSC TV set (or duplicate a tape from an NTSC VCR).
PAL-N mode	Use this mode when you playback an PAL-N tape on a PAL-N TV set (or record a video signal in the PAL-N system).

NOTES:

- The tape speed depends on the type of the received TV color system or the type of the video format of the tape to be played back. If it is PAL-N system, SP or LP appears on the TV screen. If it is NTSC system, SP or EP appears on the TV screen.
- When you do not receive an NTSC broadcast or playback an NTSC tape in NTSC mode, nothing appears on the TV screen.

Recording Features

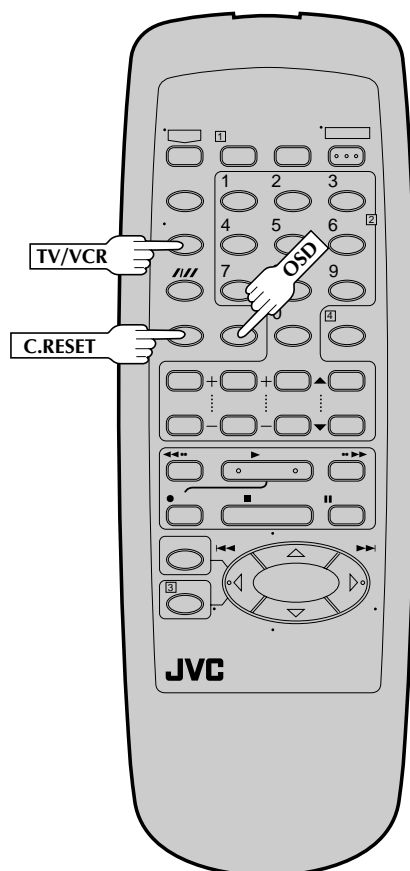

Record One Program While Watching Another

1 ENGAGE TV MODE

1

During recording...

- Press **TV/VCR**. The VCR's VCR indicator goes out. (If you are using the RF connection (☞ pg. 4) to view the output from your VCR, the TV broadcast being recorded disappears.)
- If you are using the AV connection (☞ pg. 4) to view the output from your VCR, change the TV's input mode from AV to TV.

2 SELECT CHANNEL FOR VIEWING

2

Use the TV's channel selector to set the channel you want to watch.

Display Elapsed Recording Time

1 RESET COUNTER TO ZERO

1

Before recording starts, press **C.RESET**. The counter resets to zero and displays the exact elapsed time as the tape runs.

2 DISPLAY ELAPSED TIME ON SCREEN

2

During recording, press **OSD** at any time to see the elapsed time.

All indications corresponding to the current status of the VCR are displayed for 5 seconds. The counter display remains on the screen indicating the elapsed time. Press **OSD** again to remove the display.

- Make sure "SUPERIMPOSE" is set to "ON" (☞ pg. 19).
- The indications are not recorded.

Express Timer Programming

Turn on the TV and select the VCR channel 3 or 4 (or AV mode).

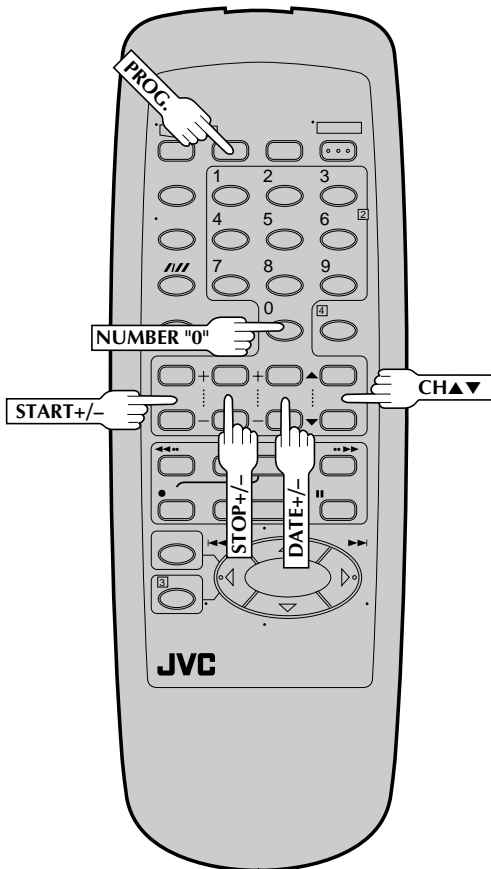
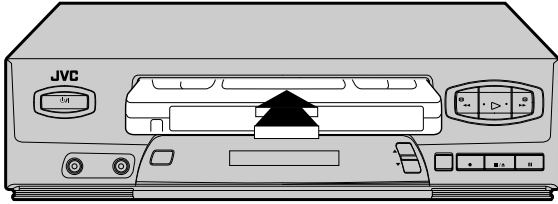

You can directly program the VCR's timer to record up to 8 shows, as far as a year in advance. Remember, the clock must be set before you can program the timer (☞ pg. 6 or 9).

1

LOAD A CASSETTE

Make sure the record safety tab is intact. If not, cover the hole with adhesive tape, then load it into the VCR.

- The VCR comes on, and the counter is reset, automatically.

2

ACCESS PROGRAM SCREEN

Press **PROG.** (If you're just starting out, "PROGRAM 1" appears.)

PROGRAM 1	
START	STOP
---:--	→ ---:--
DATE	CH
--/--	--- SP
PRESS (+/-, SP/LP, 8=DAILY, 9=WEEKLY), THEN (OK)	
PRESS (PROG.) TO END	

3

SET PROGRAM START TIME

Press **START +/-** to enter the time you want recording to start.

- Press and hold **START +/-** to move in 30-minute increments, or press and release repeatedly to move 1 minute at a time.

PROGRAM 1	
START	STOP
20:00	→ ---:--
DATE	CH
--/--	--- SP
PRESS (+/-, SP/LP, 8=DAILY, 9=WEEKLY), THEN (OK)	
PRESS (PROG.) TO END	

4

SET PROGRAM STOP TIME

Press **STOP +/-** to enter the time you want recording to stop.

- Press and hold **STOP +/-** to move in 30-minute increments, or press and release repeatedly to move 1 minute at a time.

5

SET PROGRAM DATE

Press **DATE +/-**. (The current date is displayed on screen. The date you enter appears in its place.)

6

SET CHANNEL NUMBER

Press **CH ▲▼**.

- Holding down **CH ▲▼** rapidly scans through the channels.
- If you are using a cable box, enter the cable box channel, not the channel to be recorded. The channel to be recorded must be selected on the cable box. (The cable box channel is the VCR's channel that displays the channels received by the cable box.)
- To timer-record cable or satellite channels through an external tuner connected to the VCR's external input connectors, press the **NUMBER** key "0" so that "F-1" appears instead of a channel number.

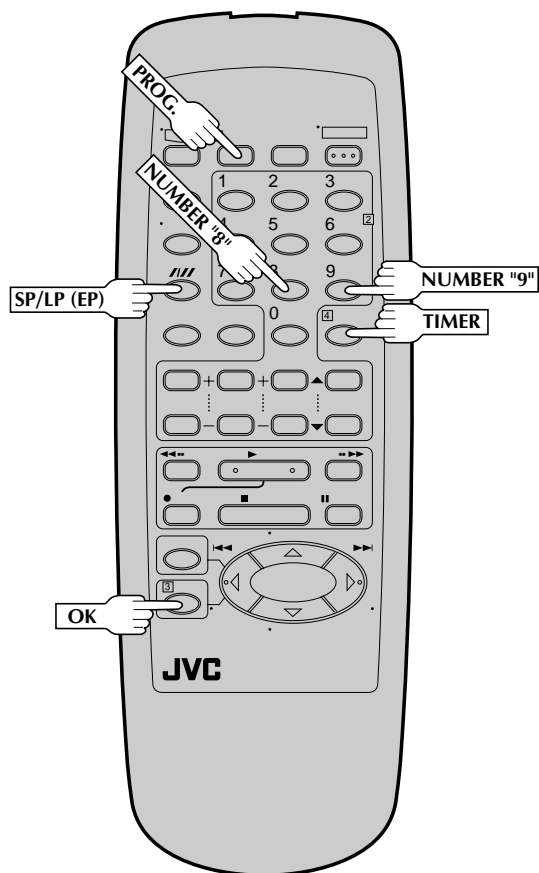

7 SET TAPE SPEED

Press **SP/LP (EP)** to set the tape speed.

8 RETURN TO NORMAL SCREEN

Press **PROG.** or **OK**. "PROGRAM COMPLETED" appears on the screen for about 5 seconds, then normal screen appears.

9 ENGAGE TIMER MODE

Press **TIMER**. The VCR turns off automatically and "⊖" is displayed on the display panel.

To Timer-Record Weekly Or Daily Serials . . .

. . . anytime during steps 2 through 8, press **WEEKLY (NUMBER key "9")** for weekly serials or **DAILY (NUMBER key "8")** for daily serials (Monday–Friday). Either "WEEKLY" or "DAILY" appears on the screen. Pressing the button again makes the corresponding indication disappear.

NOTES:

- To disengage the timer before recording starts, press **TIMER** again. Pressing once more re-engages it.
- In case of a power failure after programming, the VCR's memory backup keeps your selections (if the lithium battery is not exhausted).
- Programs that start after midnight must have the next day's date.
- After timer recording is completed, the VCR's power goes off automatically.
- You can program the timer while a regular recording is in progress; the on-screen menu will not be recorded.
- If the end of tape is reached during timer recording, the cassette is automatically ejected.
- When timer-recording cable or satellite channels through an external tuner, be sure to keep the cable box or satellite receiver's power ON.

ATTENTION

If there is a conflict in the timer schedule and one program overlaps with another, only the parts shown below in gray will be recorded.

Pattern 1: The program with the lower program number will be recorded.

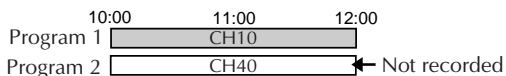

Pattern 2: The program that is broadcast earlier will be recorded.

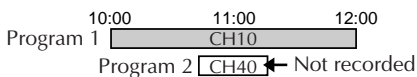

Pattern 3: The program that is broadcast earlier will be recorded, followed by the remaining portion of the other program.

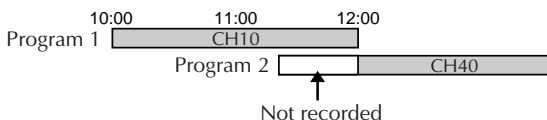

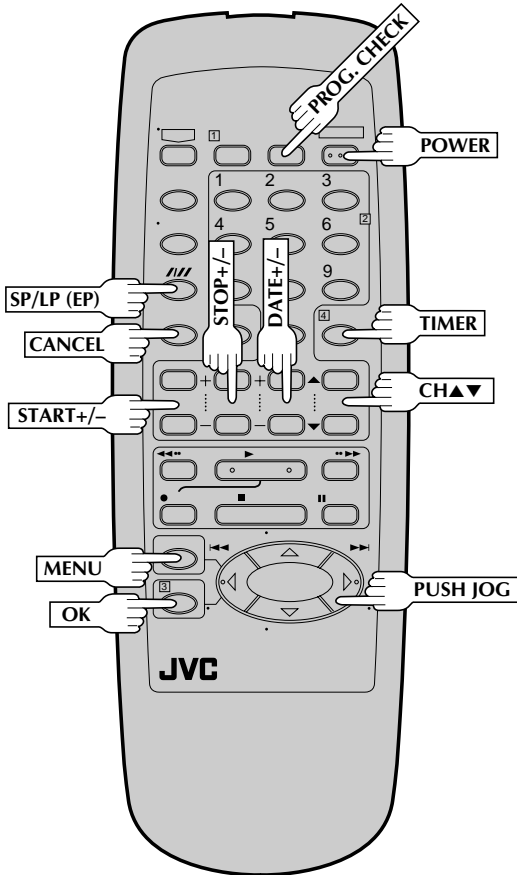
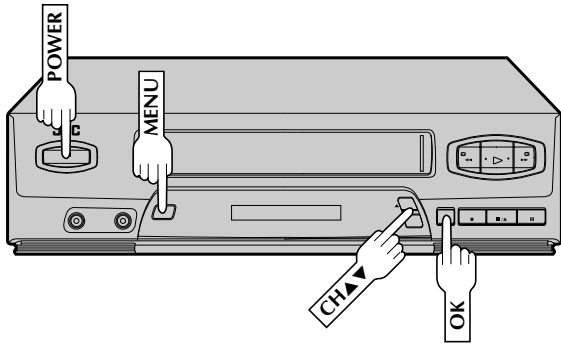

Check, Cancel And Revise Programs

1

DISENGAGE TIMER

Press **TIMER**, then press **POWER**.

2

ACCESS PROGRAM CHECK SCREEN

Press **PROG. CHECK**.

PR	START	STOP	CH	DATE
1	8:00	10:00	12	24/12
2	10:00	10:45	40	25/12
3	11:30	01:00	125	25/12
4				
5				
6				
7				
8				

PRESS (CHECK) TO NEXT

3

ACCESS PROGRAM SCREEN

Press **PROG. CHECK** again to check more information. Each time you press **PROG. CHECK**, the next program's information appears.

To Cancel Or Revise A Program...

4

CANCEL OR REVISE A PROGRAM

To cancel a program, press **CANCEL**.
To revise a program, press the appropriate button: **START+/-**, **STOP+/-**, **DATE+/-**, **CH ▲▼**, **SP/LP (EP)**.

5

RETURN TO NORMAL SCREEN

Press **PROG. CHECK** as many times as necessary. If there are still programs remaining, go to step 6.

6

RE-ENGAGE TIMER

Press **TIMER**.

Auto SP→LP Timer

If there is not enough tape to record the entire program in SP mode, the VCR automatically switches to LP (with PAL-N) or EP (with NTSC) mode to allow complete recording.

For Example . . .

Recording a program of 210 minutes in length onto a 180-minute tape

Approximately 150 minutes	Approximately 60 minutes
SP mode	LP (EP) mode
Total 210 minutes	

Make sure you select "ON" at the Auto SP→LP Timer screen before performing timer programming.

1 ACCESS MAIN MENU SCREEN

Press **MENU**.

2 ACCESS FUNCTION SET SCREEN

Move the highlight bar (arrow) to "FUNCTION SET" by pressing **CH ▲▼** or **PUSH JOG Δ▽**, then press **OK** or **PUSH JOG ▷**.

3 SELECT AUTO SP→LP TIMER SET MODE

Move the highlight bar (arrow) to "AUTO SP→LP TIMER" by pressing **CH ▲▼** or **PUSH JOG Δ▽**, then press **OK** or **PUSH JOG ▷** to set to "ON" or "OFF".

FUNCTION	
AUTO TIMER	OFF
SUPERIMPOSE	ON
→ AUTO SP→LP TIMER	ON
B.E.S.T.	ON
VIDEO SYSTEM	AUTO

SELECT WITH (▲, ▼) AND (OK)
PRESS (MENU) TO END

4 RETURN TO NORMAL SCREEN

Press **MENU**.

Auto Timer

When the Auto Timer is set to ON the timer is automatically engaged when the VCR's power is turned off. It is automatically disengaged when the VCR is powered back on.

1 ACCESS MAIN MENU SCREEN

Press **MENU**.

2 ACCESS FUNCTION SET SCREEN

Move the highlight bar (arrow) to "FUNCTION SET" by pressing **CH ▲▼** or **PUSH JOG Δ▽**, then press **OK** or **PUSH JOG ▷**.

3 SELECT AUTO TIMER SET MODE

Move the highlight bar (arrow) to "AUTO TIMER" by pressing **CH ▲▼** or **PUSH JOG Δ▽**, then press **OK** or **PUSH JOG ▷** to set to "ON" or "OFF".

FUNCTION	
→ AUTO TIMER	OFF
SUPERIMPOSE	ON
AUTO SP→LP TIMER	OFF
B.E.S.T.	ON
VIDEO SYSTEM	AUTO

SELECT WITH (▲, ▼) AND (OK)
PRESS (MENU) TO END

4 RETURN TO NORMAL SCREEN

Press **MENU**.

NOTE:

For safety, when "AUTO TIMER" is set to "OFF", all other VCR functions are disabled while the Timer mode is engaged. To disengage the timer, press **TIMER**.

NOTES:

- If you have programmed the VCR to timer-record 2 or more programs, the second program and those thereafter may not fit on the tape if you set the Auto SP→LP Timer mode to "ON". In this case, make sure the mode is not engaged, then set the tape speed manually during timer programming.
- In order to ensure that the recording fits on the tape, this feature may leave a slight non-recorded section at the end of the tape.
- There may be some noise at the point on the tape where the VCR switches from SP to LP (or EP) mode.
- The Auto SP→LP Timer feature is not available during ITR (Instant Timer Recording), and the feature will work with the following tapes: T-30, T-60, T-90, and T-120.

Instant Timer Recording (ITR)

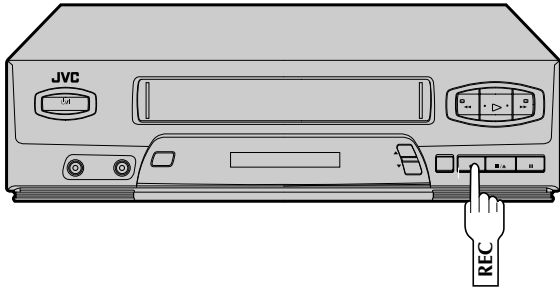

This easy method lets you record from 30 minutes to 6 hours (selectable in 30-min. increments) and shuts the VCR off after recording is finished.

1 START RECORDING

Press **REC** on the front panel.

2 ENGAGE ITR MODE

Press **REC** again. "⦿" blinks and 0:30 appears on the front display panel.

3 SET RECORDING DURATION

If you want to record for more than 30 minutes, press **REC** to extend the time. Each press extends recording time by 30 minutes.

NOTES:

- You can only perform ITR using the **REC** button on the VCR's front panel.
- After you set the ITR time, the previous display reappears.
- To check the remaining time, press **REC** once during recording and the remaining time will be displayed for about 5 seconds. Be careful not to press **REC** again within these 5 seconds, or you will round the recording time up to the next 30 minute increment.

Edit To Another VCR

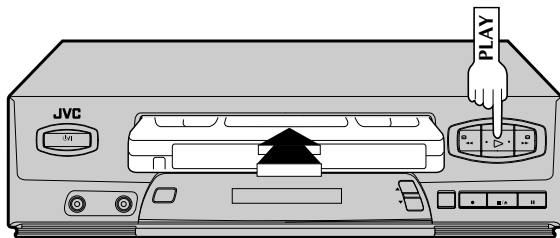
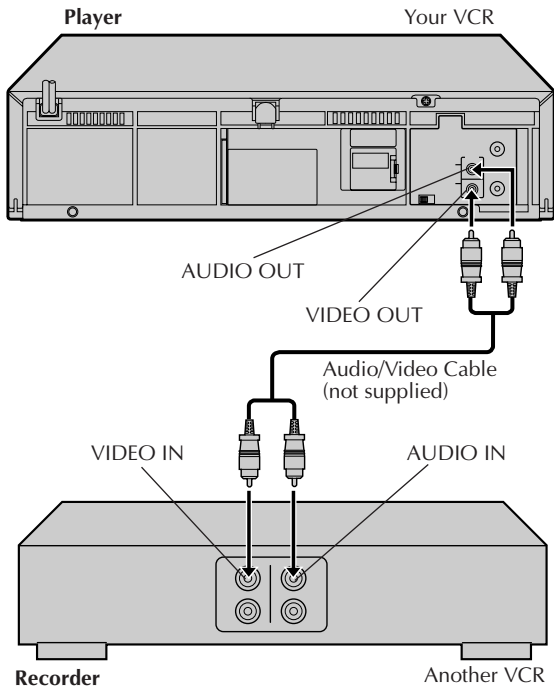

You can use your VCR as the player and another VCR as the recorder.

- 1 MAKE CONNECTIONS**
 Connect an Audio/Video cable between your VCR's VIDEO OUT and AUDIO OUT connectors and another VCR's VIDEO IN and AUDIO IN connectors.
 - When connecting to a Hi-Fi VCR, connect your VCR's AUDIO OUT connector to the AUDIO IN L connector on the Hi-Fi VCR.
- 2 LOAD CASSETTES**
 Insert the playback cassette into your VCR and the cassette to be recorded on into the other VCR.
- 3 SET RECORDER'S INPUT MODE**
 Set the other VCR's auxiliary (AV) input mode.
- 4 START PLAYER**
 Press **PLAY** on your VCR.

NOTE:
 If you don't want to record the superimposed indication on the edited tape, be sure to set "SUPERIMPOSE" to "OFF" before pressing **PLAY** (☞ pg. 19).
- 5 START RECORDER**
 Set the other VCR to its record mode.

Edit From A Camcorder Or Another VCR

You can use a camcorder or another VCR as the player and your VCR as the recorder.

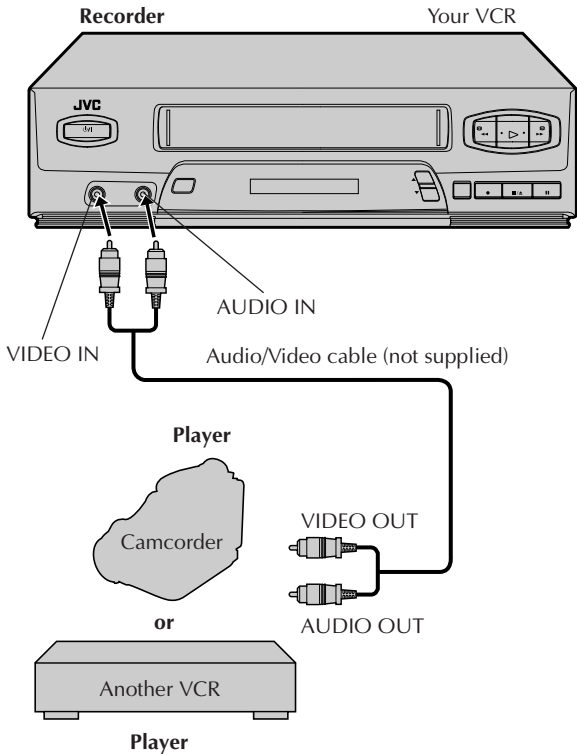

1 MAKE CONNECTIONS

Connect an Audio/Video cable between the camcorder's or the playback VCR's VIDEO OUT and AUDIO OUT connectors and your VCR's VIDEO IN and AUDIO IN connectors.

- When using a Hi-Fi camcorder or a Hi-Fi VCR, connect its AUDIO OUT L connector to the AUDIO IN connector on your VCR.

2 LOAD A CASSETTE

Insert the cassette to be recorded on into your VCR and the playback cassette into the camcorder or the playback VCR.

3 SET RECORDER'S INPUT MODE

Press **NUMBER** key "0" to set your VCR to F-1.

4 START PLAYER

Set the camcorder or the playback VCR to its play mode.

NOTE:

If the camcorder or another VCR is equipped with a superimpose/OSD disable feature then set its superimpose or display feature to OFF before pressing play.

5 START RECORDER

Set your VCR to its record mode.

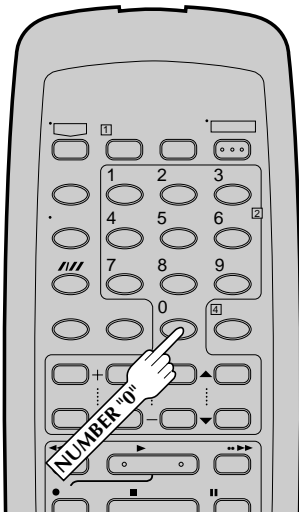

PLAYBACK

- Q. What happens if the end of the tape is reached during playback or search?**
 A. The tape is automatically rewound to the beginning.

- Q. Can the VCR indefinitely remain in the still mode?**
 A. No. It stops automatically after 5 minutes to protect the heads.

- Q. During search, slow, still and frame-by-frame playback, I can't hear any audio. What's the problem?**
 A. This is normal.

- Q. During search, still and frame-by-frame playback, the picture is intermittent. What's the cause?**
 A. Picture loss occurs when these types of playback are attempted with a tape recorded in LP mode. Pressing **PLAY** to return to normal playback will restore the picture.

- Q. When returning from multi-speed search to normal playback, the picture is disturbed. Should I be concerned about this?**
 A. No, it is normal.

- Q. Noise bars appear during multi-speed search. What's the problem?**
 A. This is normal.

- Q. When playing back programs that have been timer-recorded with consecutive times (such one program from 8:00 to 9:00 and another one from 9:00 to 10:00), the picture and sound become momentarily distorted at the point where the first program ends and the second program begins. Is this a malfunction?**
 A. No. This is normal.

- Q. Other than preventing further recording, what effect does removing the safety tab have?**
 A. It disables marking of index codes.

- Q. Sometimes, during Index Search, the VCR can't find the program I want to see. Why not?**
 A. There may be index codes too close together.

- Q. During playback, on-screen operational indicators sometimes jitter. Why does this happen?**
 A. If the condition of the tape being played back is not good, jittering of the video (including on-screen indicators) may occur.

RECORDING

- Q. When I pause and then resume a recording, the end of the recording before the pause is overlapped by the new recording. Why does this happen?**
 A. This is normal. It reduces distortion at the pause and resume points.

- Q. Can the VCR indefinitely remain in the Record-Pause mode?**
 A. No. The VCR automatically goes to its Stop mode after 5 minutes to protect the heads. When paused during Instant Timer Recording (ITR), the VCR shuts off automatically after 5 minutes.

- Q. What happens if the tape runs out during recording?**
 A. The VCR automatically rewinds it to the beginning.

TIMER RECORDING

- Q. REC and ⊖ remain lit on the front display panel. Is there a problem?**
 A. No. This is a normal condition for a timer recording in progress.

- Q. Can I program the timer while I'm watching a tape or a TV broadcast?**
 A. Yes, but while you are setting the timer you won't see the tape's or broadcast program's picture as it is replaced by the on-screen menu. The audio from the tape or broadcast program will be present during the setting of the timer.

Before requesting service for a problem, use this chart and see if you can repair the trouble yourself. Small problems are often easily corrected, and this can save you the trouble of sending your VCR off for repair.

POWER

SYMPTOM	POSSIBLE CAUSE	CORRECTIVE ACTION
1. The power won't come on.	<ul style="list-style-type: none"> • The power cord is disconnected. 	Connect the power cord.
2. The clock works, but the VCR's power won't come on.	<ul style="list-style-type: none"> • The timer mode is engaged with Auto Timer set to "OFF" (☞ pg. 27). 	Press TIMER to disengage.
3. The remote control won't function.	<ul style="list-style-type: none"> • The batteries are discharged. 	Replace the dead batteries with new ones.

TAPE TRANSPORT

SYMPTOM	POSSIBLE CAUSE	CORRECTIVE ACTION
1. The cassette gets stuck partway during loading, and is ejected.	<ul style="list-style-type: none"> • The cassette was inserted incorrectly. 	Make sure the cassette's window is facing up, the rear label side is facing you and the arrow on the front of the cassette is pointing towards the VCR. Then insert the cassette.









PLAYBACK

SYMPTOM	POSSIBLE CAUSE	CORRECTIVE ACTION
1. The tape is running but the picture won't appear.	<ul style="list-style-type: none"> • If you're using the RF OUT connection (☞ pg. 4), the channel selector on the TV is set incorrectly. • If you're using the AV connection (☞ pg. 4), the TV is set to the wrong mode. 	Set the channel selector to channel 3 or 4. Set the TV to its AV mode.
2. Noise appears during visual search.	<ul style="list-style-type: none"> • This is normal. 	
3. The playback picture is blurred or interrupted, even though TV broadcasts are clear.	<ul style="list-style-type: none"> • The video heads may be dirty. 	The heads must be cleaned. Consult your JVC dealer.

RECORDING

SYMPTOM	POSSIBLE CAUSE	CORRECTIVE ACTION
1. Recording won't start.	<ul style="list-style-type: none"> • There's no cassette loaded. • The loaded cassette has had its record safety tab removed. 	Insert a cassette. Remove the cassette and cover the hole with adhesive tape, or load a cassette on which the record safety tab is intact.
2. TV broadcasts won't record properly.	<ul style="list-style-type: none"> • The VCR has been set to its AUX mode by mistake. 	Set the VCR to the appropriate channel.
3. Tape-to-tape editing won't work.	<ul style="list-style-type: none"> • The VCRs or the camcorder and the VCR have been incorrectly connected. • The power to one or more of the units has not been turned on. • The recorder's input mode has been set incorrectly. 	Refer to the directions and the illustration under "Edit To Another VCR" (☞ pg. 29) or "Edit From A Camcorder Or Another VCR" (☞ pg. 30) and properly connect the units. Make sure the power to all units is on. Select the recorder's appropriate input mode.

TIMER RECORDING

SYMPTOM	POSSIBLE CAUSE	CORRECTIVE ACTION
1. Timer recording won't work.	<ul style="list-style-type: none"> • The clock and/or the timer have been set incorrectly. • The timer is not engaged. 	<p>Set the clock and/or timer correctly.</p> <p>Press TIMER and check to make sure that  appears on the front display panel. Re-perform the set-up procedures.</p>
2. Timer programming won't work.	<ul style="list-style-type: none"> • The VCR has not been set up properly. 	<ul style="list-style-type: none"> • Timer recording is in progress. <p>Timer programming can't be performed when timer recording is in progress. Wait until it finishes.</p>
3.  and  on the front display panel won't stop blinking.	<ul style="list-style-type: none"> • The timer is engaged but there's no cassette loaded. 	<p>Load a cassette with the record safety tab intact, or with the hole covered with adhesive tape.</p>
4. The cassette is automatically ejected, and  and  on the front display panel won't stop blinking.	<ul style="list-style-type: none"> • The loaded cassette has had its record safety tab removed. 	<p>Remove the cassette and cover its hole with adhesive tape, or replace it with a cassette on which the safety tab is intact.</p>
5.  blinks for 10 seconds and the timer mode is disengaged.	<ul style="list-style-type: none"> • TIMER has been pressed when there are no programs in memory, or the timer record program information has not been programmed correctly. 	<p>Check the programmed data and re-program as necessary, then press TIMER again.</p>
6. The cassette is automatically ejected, the power shuts off and  and  won't stop blinking.	<ul style="list-style-type: none"> • The end of tape was reached during timer recording. 	<p>The program may not have been recorded in its entirety. Next time make sure you have enough time on the tape to record the entire program.</p>
7. "PROGRAM FULL" is displayed on the screen.	<ul style="list-style-type: none"> • All 8 programs of the VCR's timer memory are used. 	<p>Wait until a space in memory clears, or cancel unnecessary program information ( pg. 26).</p>

OTHER PROBLEMS

SYMPTOM	POSSIBLE CAUSE	CORRECTIVE ACTION
1. When scanning channels, some of them are skipped over.	<ul style="list-style-type: none"> • Those channels have been preset to be skipped. 	<p>If you need the skipped channels, restore them ( pg. 13).</p>
2. The channel can't be changed.	<ul style="list-style-type: none"> • Recording is in progress. 	<p>Press PAUSE to pause the recording, change channels, then press PLAY to resume recording.</p>

ATTENTION

This VCR contains microcomputers. External electronic noise or interference can cause microcomputer to malfunction. If the VCR does not operate correctly switch its power off and unplug the power cord from the AC supply. Wait for a while and then plug the power back in. Eject and check the condition of the cassette. If everything appears normal resume operating the VCR as usual.

FRONT VIEW

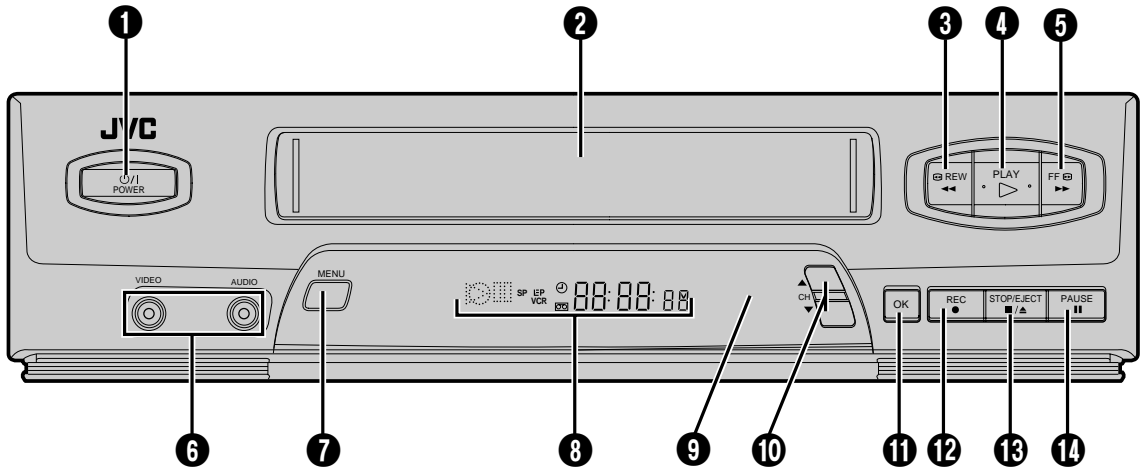

- ❶ POWER ψ /I Button (☞ pg. 6)
- ❷ Cassette Loading Slot
- ❸ Rewind [REW] Button (☞ pg. 14)
- ❹ PLAY Button (☞ pg. 14)
- ❺ Fast-Forward [FF] Button (☞ pg. 14)
- ❻ VIDEO/AUDIO Input Connectors (☞ pg. 30)
- ❼ MENU Button (☞ pg. 7)
- ❽ Front Display Panel (☞ pg. 35)
- ❾ Remote Control Sensor
- ❿ Channel [CH] \blacktriangle / \blacktriangledown Button (☞ pg. 15, 24)
- ⓫ OK Button (☞ pg. 6)
- ⓬ Record [REC] Button (☞ pg. 15)
- ⓭ STOP/EJECT Button (☞ pg. 14)
- ⓮ PAUSE Button (☞ pg. 16)

REAR VIEW

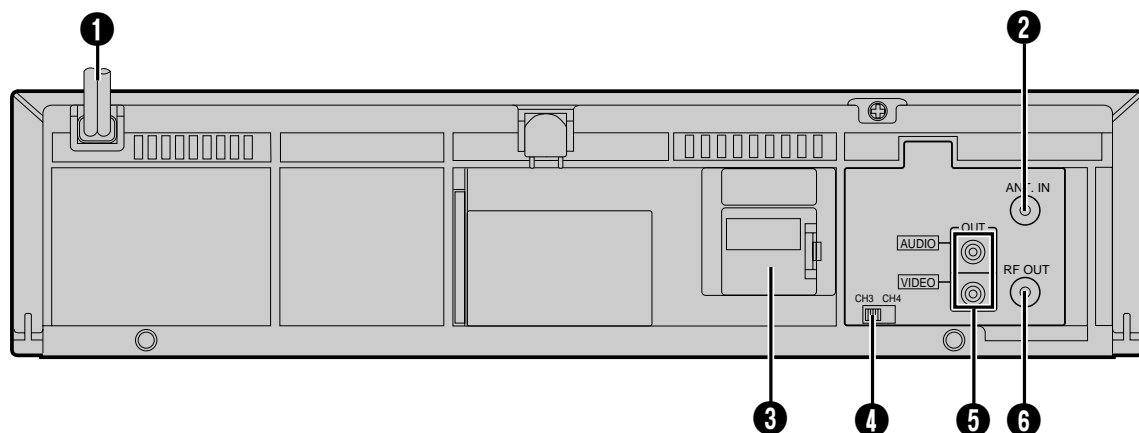

- ❶ Power Cord (☞ pg. 4)
- ❷ ANT. IN Connector (☞ pg. 4)
- ❸ Lithium Battery Compartment (☞ pg. 4)

- ❹ CH (Channel) 3/4 Switch (☞ pg. 4)
- ❺ VIDEO/AUDIO Output Connectors (☞ pg. 29)
- ❻ RF OUT Connector (☞ pg. 4)

FRONT DISPLAY PANEL

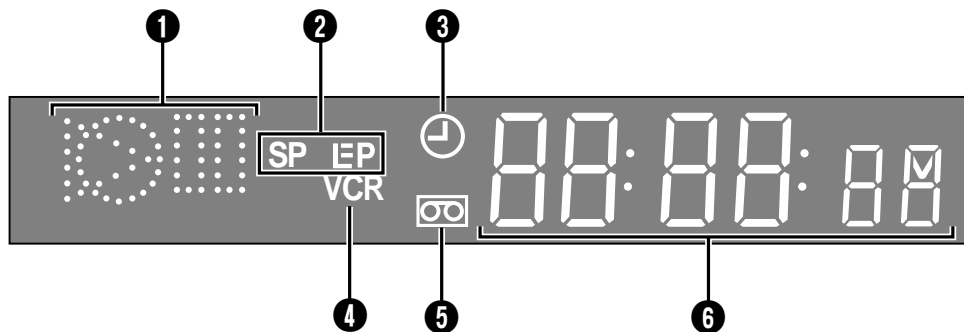

- ❶ Symbolic Mode Indicators

PLAY: FF/REW VARIABLE SEARCH:	▶	STILL: SLOW:	▶
		RECORD:	○
		RECORD PAUSE:	○

- ❷ Tape Speed Indicators (☞ pg. 15)
- ❸ Timer Mode Indicator
- ❹ VCR Mode Indicator (☞ pg. 23)
- ❺ "Cassette Loaded" Mark
- ❻ Channel Display ["F-1" for AUX mode]
Counter Display (☞ pg. 14)
Clock Display (☞ pg. 6)

REMOTE CONTROL

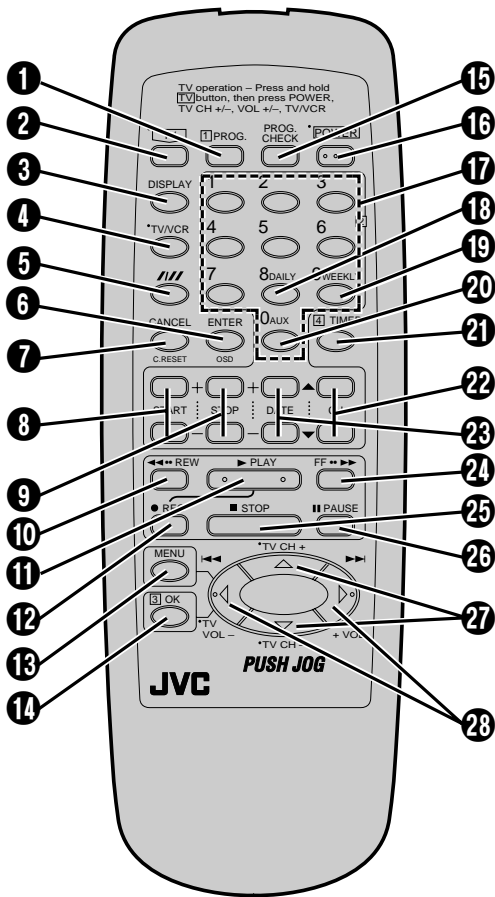

Buttons with a small dot on the left side of the name can also be used to operate your JVC TV while holding down the TV button.

- 1 PROG. Button (☞ pg. 24)
- 2 TV Button (See below)
- 3 DISPLAY Button (☞ pg. 18)
- 4 TV/VCR Button (☞ pg. 23)
- 5 Recording Speed [SP/LP (EP)] Button (☞ pg. 15)
- 6 ENTER Button (☞ pg. 15)
- 7 On-Screen Display [OSD] Button (☞ pg. 19)
- 8 CANCEL Button (☞ pg. 26)
- 9 Counter [C.] RESET Button (☞ pg. 18)
- 8 START +/- Button (☞ pg. 24)
- 9 STOP +/- Button (☞ pg. 24)
- 10 Rewind [REW] Button (☞ pg. 14)
- 11 PLAY Button (☞ pg. 14)
- 12 Record [REC] Button (☞ pg. 15)
- 13 MENU Button (☞ pg. 7)
- 14 OK Button (☞ pg. 6)
- 15 PROG. CHECK Button (☞ pg. 26)
- 16 POWER \uparrow/\downarrow Button (☞ pg. 6)
- 17 NUMBER Buttons (☞ pg. 15)
- 18 DAILY Timer Recording Button (☞ pg. 25)
- 19 WEEKLY Timer Recording Button (☞ pg. 25)
- 20 "AUX" Mode Select Button (☞ pg. 29)
- 21 TIMER Button (☞ pg. 25)
- 22 Channel [CH] $\blacktriangle/\blacktriangledown$ Button (☞ pg. 15, 24)
- 23 DATE +/- Button (☞ pg. 24)
- 24 Fast-Foward [FF] Button (☞ pg. 14)
- 25 STOP Button (☞ pg. 14)
- 26 PAUSE Button (☞ pg. 16)
- 27 PUSH JOG $\blacktriangle/\blacktriangledown$ Button (☞ pg. 6)
- TV Channel [CH] +/- Button (See below)
- 28 PUSH JOG $\blacktriangleleft/\blacktriangleright$ Button (☞ pg. 16, 17)
- TV Volume [VOL] +/- Button (See below)

Installing Batteries

- 1 Open the battery compartment cover.
- 2 Insert 2 "AA"-size batteries (provided) in the direction indicated under the battery cover.
- 3 Replace the cover.

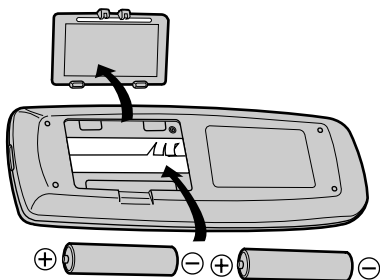

How To Use

The remote control can operate most of your VCR's functions.

- 1 Point the remote control toward the sensor window.
- 2 Press the appropriate operation button.
- 3 The maximum operating distance of the remote control is about 8 m.

Operating JVC TVs

To operate your TV, while holding down TV, press the corresponding button: POWER, TV/VCR, TV CH +/- . TV VOL +/- can be used without holding down TV.

NOTES:

- Depending on the type of JVC TV, there may be cases where some or all functions cannot be operated using the remote control.
- If the remote control doesn't work properly, remove its batteries, wait a short time, replace the batteries and then try again.

GENERAL

Power requirement	: AC 110 - 220 V \sim , 50/60 Hz
Power consumption	
Power on	: 20 W
Power off	: 5 W
Temperature	
Operating	: 5°C to 40°C (41°F to 104°F)
Storage	: -20°C to 60°C (-4°F to 140°F)
Operating position	: Horizontal only
Dimensions (W x H x D)	: 360 x 94 x 273 mm (14-3/16" x 3-3/4" x 10-3/4")
Weight	: 3.0 kg (6.6 lbs)
Format	: VHS NTSC standard
Maximum recording time	
SP	: 240 min. with E-240 (PAL-N) video cassette
	: 160 min. with T-160 (NTSC) video cassette
LP	: 480 min. with E-240 (PAL-N) video cassette
EP	: 480 min. with T-160 (NTSC) video cassette

VIDEO/AUDIO

Signal system	: PAL-N-type color signal and CCIR monochrome signal, 625 lines/50 fields
	: NTSC-type color signal and EIA monochrome signal, 525 lines/60 fields
Recording/ Playback system	: DA-4 (Double Azimuth) head helical scan system
Signal-to-noise ratio	: 45 dB
Horizontal resolution	: 240 lines (PAL-N) : 230 lines (NTSC)
Frequency range	
Normal audio	: 70 Hz to 10,000 Hz
Input/Output	: RCA connectors (IN x 1, OUT x 1)

TUNER

Tuning system	: Frequency-synthesized tuner
Channel coverage	
VHF	: Channels 2-13
UHF	: Channels 14-69
CATV	: 113 Channels
RF output	: Channel 3 or 4 (switchable; preset to Channel 3 when shipped) 75 ohms, unbalanced

TIMER

Clock reference	: Quartz
Program capacity	: 1-year programmable timer/ 8 programs
Memory backup time	: Approx. 6 months Estimated figure based on supplied fresh battery; actual performance may differ.

ACCESSORIES

Provided accessories	: RF cable, Infrared remote control unit, Lithium battery CR2025, "AA" battery x 2
----------------------	---

Specifications shown are for SP mode unless otherwise specified. E. & O.E. Design and specifications subject to change without notice.

Failure to heed the following precautions may result in damage to the VCR, remote control or video cassette.

1. DO NOT place the VCR . . .

- ... in an environment prone to extreme temperatures or humidity.
- ... in direct sunlight.
- ... in a dusty environment.
- ... in an environment where strong magnetic fields are generated.
- ... on a surface that is unstable or subject to vibration.

2. DO NOT block the VCR's ventilation openings.

3. DO NOT place heavy objects on the VCR or remote control.

4. DO NOT place anything which might spill on top of the VCR or remote control.

5. AVOID violent shocks to the VCR during transport.

****MOISTURE CONDENSATION**

Moisture in the air will condense on the VCR when you move it from a cold place to a warm place, or under extremely humid conditions—just as water droplets form on the surface of a glass filled with cold liquid. Moisture condensation on the head drum will cause damage to the tape. In conditions where condensation may occur, keep the VCR's power turned on for a few hours to let the moisture dry before inserting a tape.

****ABOUT HEAD CLEANING**

Accumulation of dirt and other particles on the video heads may cause the playback picture to become blurred or interrupted. Be sure to contact your nearest JVC dealer if such troubles occur.

